

# *WEST CAMPUS SOLAR PROJECT*

PRESENTATION TO THE DC ZONING COMMISSION  
JANUARY 6, 2022

## MEETING DC'S RENEWABLE ENERGY CHALLENGE

# A SOLAR ENERGY RESEARCH, LEARNING & PRODUCTION FACILITY

Unique public + private partnership to create one of the largest solar power arrays in the District of Columbia and greater DMV

- Supports achievement of the District's renewable energy goals by increasing the supply of locally-generated, green energy to the local utility grid
- Benefits DC energy consumers, including the University as well as surrounding local households and businesses
- Creates learning opportunities for Ward 5 and other District high school and university students
- Helps the University answer the Pope's call in his *Laudato Si'* Encyclical on environmental stewardship and taking care of our common home

Requires an Amendment to the University's approved 2012-2027 Campus Master Plan and Further Processing of the Campus Master Plan



# PROJECT LOCATION: CATHOLIC UNIVERSITY'S WEST CAMPUS

Location of Proposed Solar Project



DuFour Athletic Center

Brookland -CUA Metro Station

Monroe Street Market

Basilica of the National Shrine of the Immaculate Conception

## West Campus: SQUARE 3663 LOT 7

Bordered by:

- St. John Paul II National Shrine to the north
- Harewood Road and Main Campus to the east
- Prayer Garden and parking lot for the Basilica to the south
- North Capitol Street to the west
- No adjacent residential neighborhoods



# WEST CAMPUS SITE BACKGROUND AND HISTORY

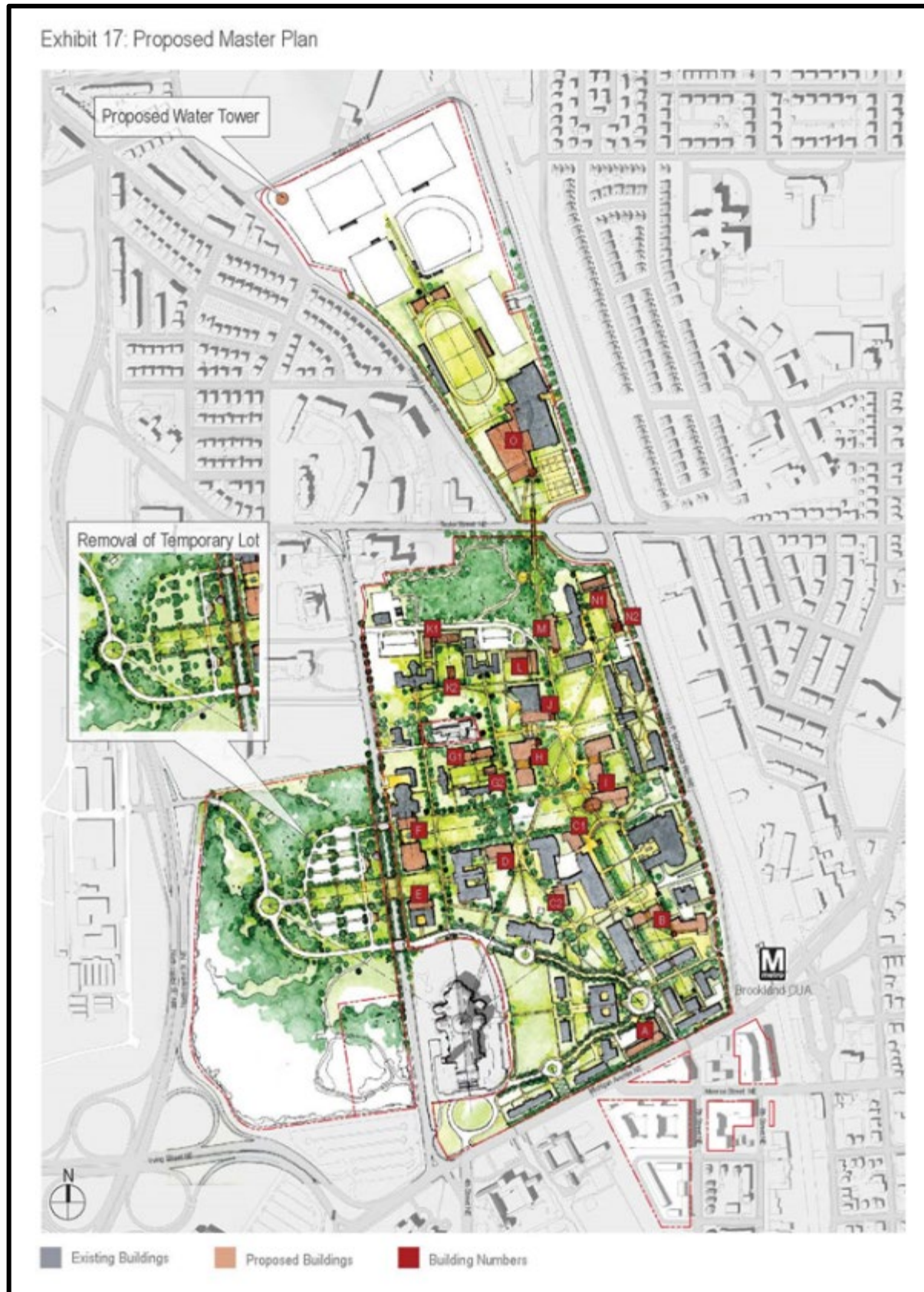

**April 2004:** The University acquired approximately 46 acres from the Armed Forces Retirement Home (AFRH) that became known as the “West Campus.” The site, surrounded by an existing iron fence, included existing utility easements along a private drive (“Scale Gate Road”) and the northern property boundary.

**June 2005:** ZC No. 04-25 established R-5-A zoning (now called RA-1) on the previously unzoned (federal) property

**July 2005:** ZC No. 04-25A amended the University’s 2002 Campus Master Plan to include the West Campus with minimal proposed uses.

**May 2012:** ZC No. 12-01 approved the University’s 15-year Campus Master Plan (2012-2027); cited the pending sale of 5 acres in the southeast corner of West Campus to the Basilica; introduced a new vehicular approach to Main Campus through West Campus from North Capitol Street; allowed for temporary surface parking.

**July 2012:** The University sold 5 acres to the Basilica, subdividing Parcel 121/29 of Square 3663 into Lot 6 (5 acres) and Lot 7 (approx 41 acres).



# WEST CAMPUS SITE DESCRIPTION



## EXISTING CONDITIONS AND SITE CHARACTERISTICS:

- Remnant forest is a dominant characteristic of southwestern third of property
- Remaining portion is characterized by open space and second growth; open space was most recently used as a temporary soil stockpile area for the recently completed Energy Infrastructure project on Main Campus
- Special trees and heritage trees have been inventoried
- A tree nursery staging area is located in the northwest corner
- Existing, small maintenance/storage facilities are located near private drive (“Scale Gate Road”)
- An existing vacant gate house is located near the curb cut on Harewood Road just inside iron fence and gate
- Existing rough-graded road bed aligns with the 2012 Campus Master Plan future North Capitol Street approach drive
- Fully surrounded by institutional uses and no adjacent residences



# EXISTING SOLAR PROGRAM AT CATHOLIC UNIVERSITY

Catholic University currently has **2,600 solar panels** on 7 different flat-roofed buildings and the O'Boyle Parking Lot. At the time of its installation (2009-2010), it was one of the largest solar installations in the District of Columbia at **677 kW of installed capacity**.

The program was established through a 20-year agreement signed in 2009 between the University and Washington Gas Energy Services.



*Solar panels on roof of Gibbons Hall*



*Solar canopy at O'Boyle Parking Lot*



*Solar panels on roof of DuFour Athletic Facility*

**Green Campus Map**

- 1 AQUINAS HALL SOLAR PANELS AND GREEN ROOF**  
Two-thirds of the roof of Aquinas Hall are covered with 103 kW of solar panels. The other one-third is a green roof that absorbs rainwater and provides insulation for the building.
- 2 COLUMBUS SCHOOL OF LAW LAWN**  
This area is the green roof of an underground parking garage.
- 3 RAYMOND A. DUFOUR ATHLETIC CENTER SOLAR PANELS**  
A 318 kW solar array is on the roof of the Raymond A. DuFour Athletic Center. It produces enough energy to power 35 homes.
- 4 FATHER HALL SOLAR PANELS**  
Father's 35kW rooftop array could power 4 homes a year.
- 5 GIBBONS HALL SOLAR PANELS**  
On the roof of Gibbons Hall, one of the oldest buildings on campus is a 30kW array of solar panels. This array could power 3 homes a year.
- 6 FATHER O'CONNELL HALL LEED BUILDING**  
Father O'Connell Hall is Leadership in Environmental and Energy Design (LEED)-certified. In the renovation of this building, 95% of the existing structure was reused and 75% of demolition waste was diverted from the landfill. Low-flow plumbing fixtures achieved a 30% indoor water-use reduction. On the northeast section of Father O'Connell Hall is a green roof.
- 7 GROUNDS AND MAINTENANCE SOLAR PANELS**  
This building's roof has a 9kW array.
- 8 PANGBORN HALL SOLAR PANELS**  
This 11kW rooftop array can power the equivalent of 1 home annually.
- 9 COMMUNITY GARDEN**  
As part of a student-led effort, the University opened its community garden in 2021. The garden features vegetables and flowers for pollinators. Students, faculty, and staff can volunteer to maintain the garden.
- 10 EDWARD M. CROUGH CENTER FOR ARCHITECTURAL STUDIES LEED BUILDING**  
The Crough Center is notable as the first student-led LEED-certified building and as the first-ever LEED-certified architecture school. The building features many best practices such as efficient lighting and controls, rain gardens and cisterns, building management policies, occupant feedback and encouragement, and water-efficient plumbing fixtures.
- 11 POPE LEO LANE RAIN GARDEN**  
Pope Leo Lane features traditional bio-retention structures to mitigate stormwater runoff on campus. The gardens run alongside Pangborn Hall and feature native and adaptive plants and flowers.
- 12 MALONEY HALL LEED BUILDING**  
Maloney Hall, the recently renovated home of the Busch School of Business is LEED Gold. Its features include but are not limited to a rainwater collection system to supply the building; LED lighting to minimize electricity use; and, temperature, light, and occupancy sensors to adapt to internal and external changes thereby maintaining optimal comfort.
- 13 OPUS HALL LEED BUILDING**  
The building is 11% more energy-efficient than average residence halls. 75% of spaces have access to view and/or adequate daylight. Water fixtures are 20% more efficient than standard indoor plumbing fixtures. The building achieved a 50% reduction in potable water used for landscaping.
- 14 EDWARD J. PRZYBYLA UNIVERSITY CENTER COMPOSTING**  
Composting is available to the campus community at the Przybyla Center. The receptacles contain real-life displays that explain which items should be recycled, composted, or landfilled.
- 15 O'BOYLE HALL SOLAR PARKING LOT CANOPY**  
This parking lot has 714 solar panels that cover over 70 parking spaces. This parking lot installation also includes an electric car-charging station.

Division of Facilities Planning and Management | sustainability@cu.edu | @cuasustainability | @green\_cu



# WEST CAMPUS SOLAR PROJECT APPROACH

## West Campus Solar Project

- The surface parking lot and paving of the new campus access road indicated in the 2012 Campus Master Plan will not be implemented at this time
- The new Solar Array will cover approximately 60% of West Campus and the expected service life of the facility is 15 to 25 years
- No new curb cuts are proposed; gates on both ends of private drive to remain
- Highest quality perimeter tree stands and remnant forest will be preserved
- Heritage trees will be protected
- Landscape buffer plantings will be installed along Harewood Road to enhance street level views
- West Campus Solar Array area will support scheduled demonstration and educational visits. The University will maintain remainder of property for other research, educational, and operational uses.

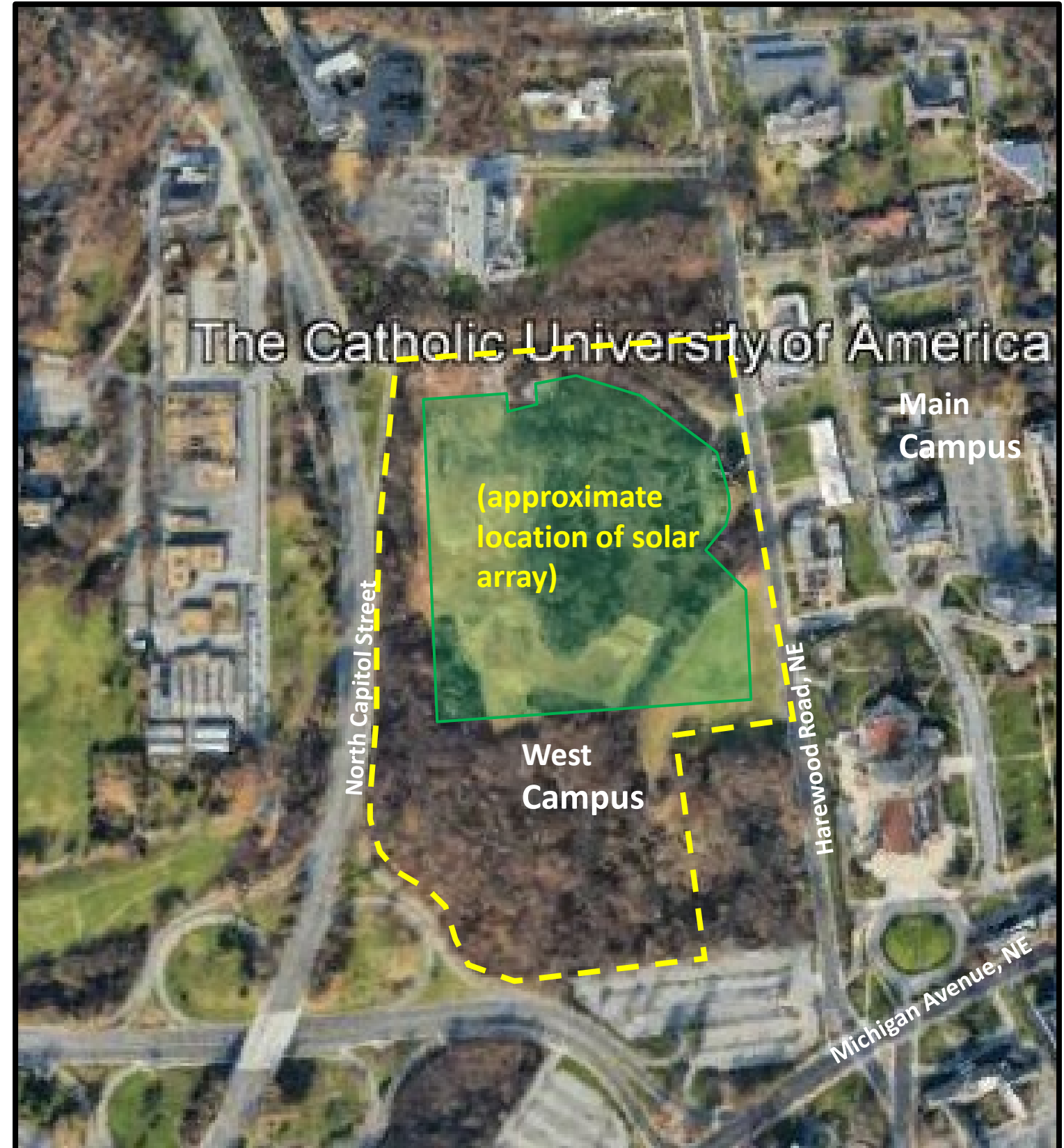

# WEST CAMPUS SITE DIAGRAM WITH SOLAR PROJECT OVERLAY

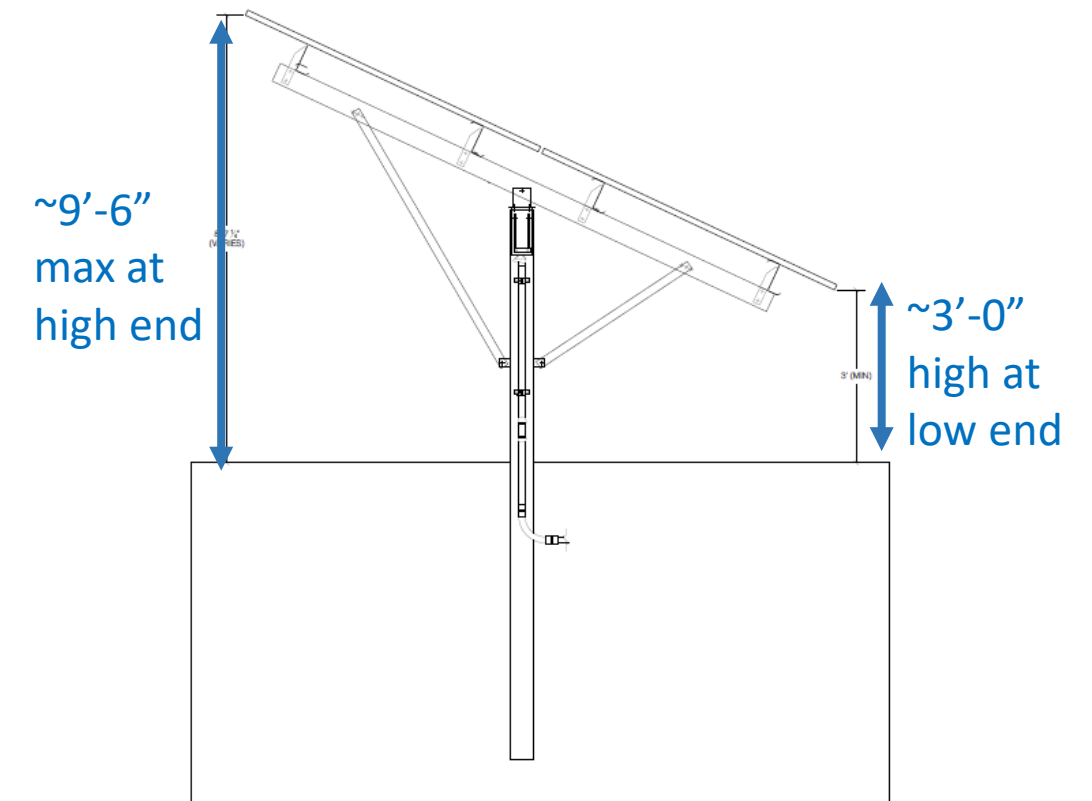
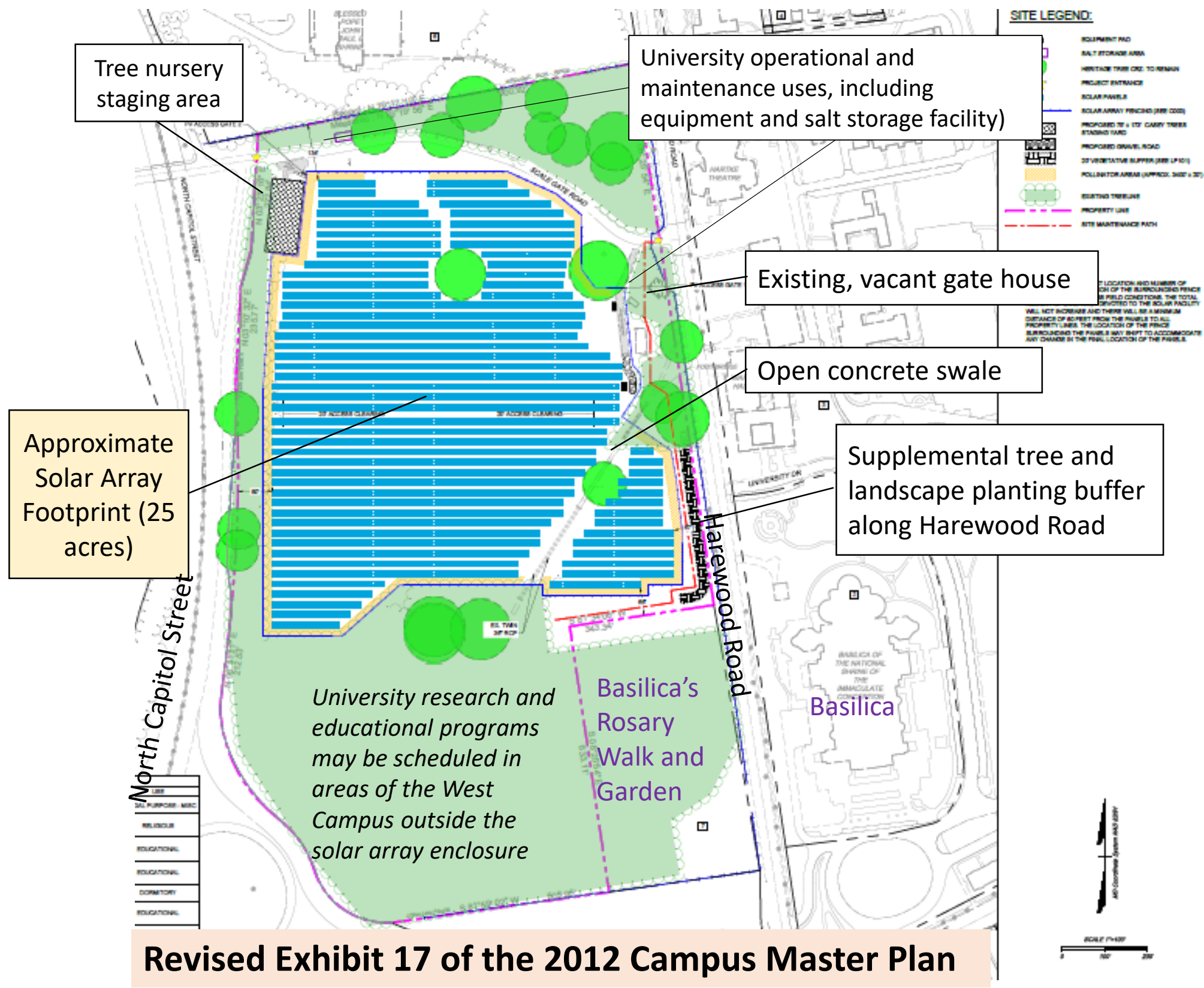

**Diagram of ground-based, fixed tilt solar panel**

Engineering underway for:  
 2 arrays of 3MW AC, each generating approximately 5,350,000 kWh/yr, for a combined capacity of 6 MW AC and a combined output exceeding 10,700,000 kWh/yr

*Flexibility in the exact location and number of panels and the location of the surrounding fence is required to address field conditions. The total amount of land area devoted to the solar facility will not increase and there will be a minimum distance of 60 feet from the panels to all property lines. The location of the fence surrounding the panels may shift to accommodate any change in the final location of the panels.*





# WEST CAMPUS SOLAR PROJECT LANDSCAPE DIAGRAMS



- Existing iron West Campus property line fence to remain
- Solar array enclosed by interior perimeter security fencing and pollinator planting area
- Existing tree cover outside solar array perimeter to remain
- Existing heritage trees protected
- Additional tree and landscape buffer proposed along Harewood Road

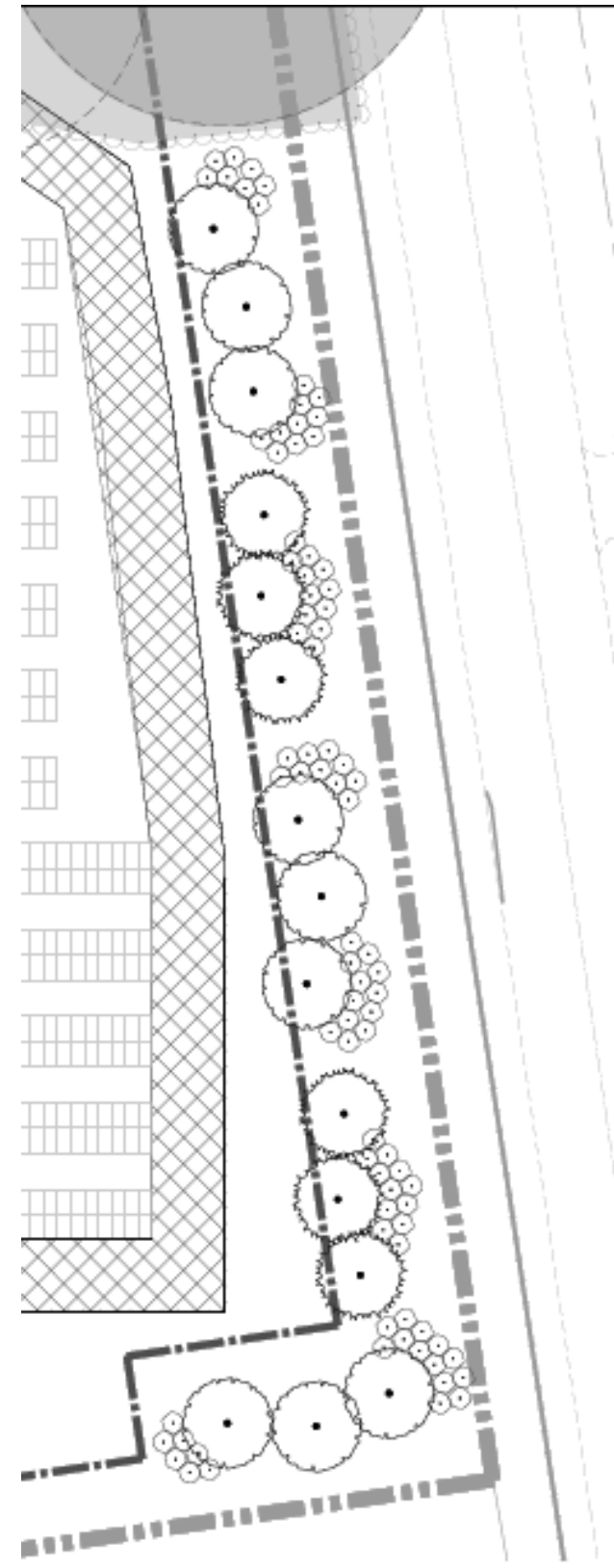

6 PLAN ENLARGEMENT  
1"=20'-0"

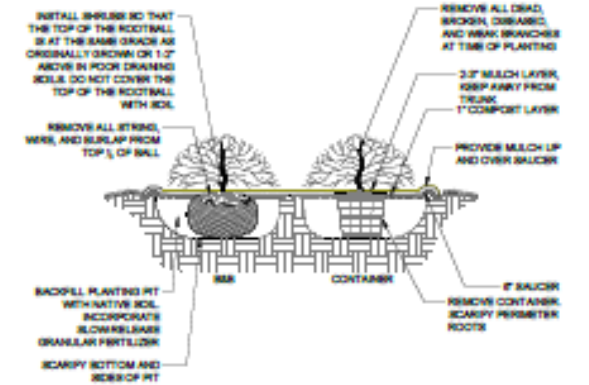

3 SHRUB PLANTING DETAIL  
1/4"=1'

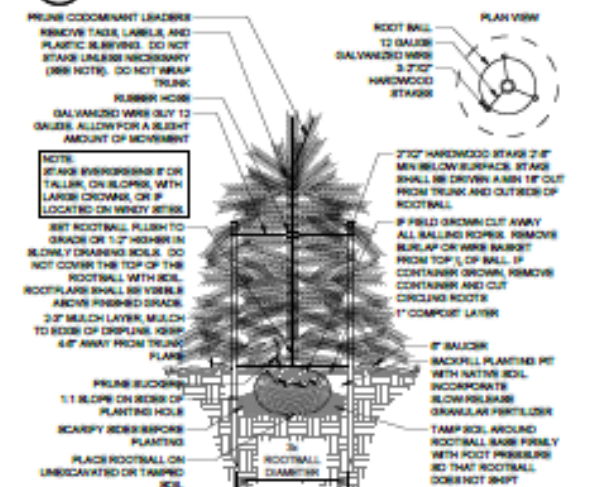

4 EVERGREEN TREE PLANTING DETAIL  
1/4"=1'

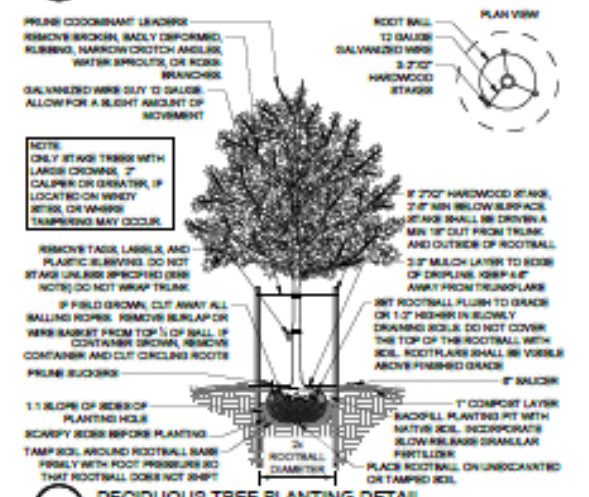

5 DECIDUOUS TREE PLANTING DETAIL  
1/4"=1'



# WEST CAMPUS SOLAR PROJECT LANDSCAPE DETAILS



*Deciduous Overstory: red oak, willow oak, red maple, American beech*

*Evergreen Overstory: loblolly pine, southern magnolia*



*Shrub understory: chokeberry, red twig dogwood, winterberry*

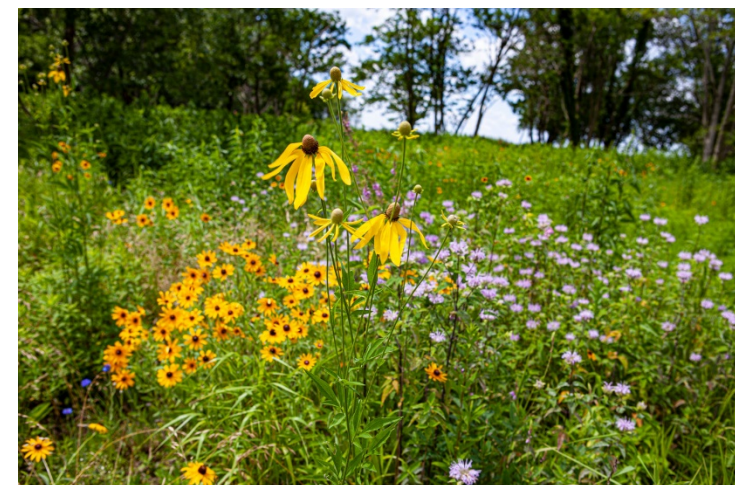

*Pollinator meadow examples*



Illustrative examples of planting materials depict design intent; final selections will be made based upon availability

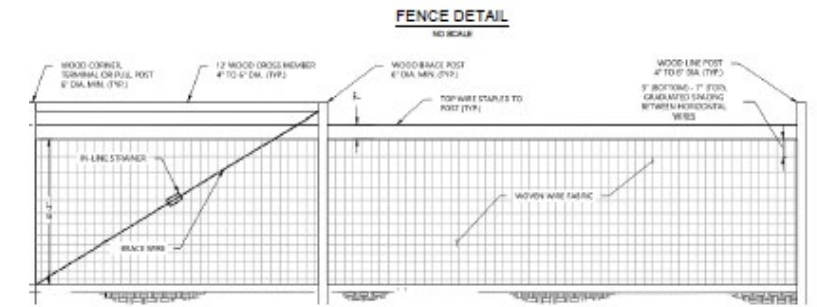

*Representative images of perimeter fence*



# WEST CAMPUS SOLAR PROJECT VISUALIZATION



Existing View looking south along Harewood Road

Rendered Views looking south along Harewood Road



5-10 year visualization of landscape buffer and pollinator growth



>10 year visualization of landscape buffer and pollinator growth



# WEST CAMPUS SOLAR PROJECT VISUALIZATION



Existing View looking north  
along Harewood Road

Rendered Views looking north along Harewood Road



5-10 year visualization of landscape buffer and pollinator growth



>10 year visualization of landscape buffer and pollinator growth



# WEST CAMPUS SOLAR PROJECT BENEFITS

## ENVIRONMENTAL STEWARDSHIP AND SUSTAINABILITY BENEFITS:

- Contributes significantly toward DC's goals of 50% Clean Power by 2032 and Carbon Neutrality by 2050
- Contributes significantly toward the University's Sustainability Plan in the spirit of Laudato Si'
- Puts into sustainable use a large, undeveloped land parcel without additional vehicles or vehicle trips
- Provides storm water management and protects Heritage Trees on the West Campus. Provides pollinator-friendly cultivation among the solar panels attracting beneficial insects and other wildlife
- Maintains and enhances picturesque character and visual aesthetic of the West Campus with setbacks and landscape screening
- Generates significantly more solar power than would be possible with individual roof installations on Main Campus, where flat roofscape configurations are scarce
- Commits to sustainable practices in site clearing and construction

## NEIGHBORHOOD, COMMUNITY, AND DISTRICT OF COLUMBIA BENEFITS:

- Contributes to advancing DC to prominence in clean power production among US cities
- Increases the supply of locally-generated, renewable energy available to surrounding community and District consumers, households, small businesses, nonprofits
- Promotes local economic development through opportunities for new jobs in solar facility design, construction and energy management
- Provides learning opportunities for local K-12 students, inspiring younger generations and instilling appreciation for sustainability and environmental stewardship.
- Enhances partnerships with Ward 5 high schools, including scholarships opportunities at Catholic University
- Enhances educational opportunities and sustainability curricula within many of the University's academic schools and departments, including Architecture, Engineering, STEM, Business, and Law

