

0:\PROJECTS\166500-7000\8816 - WASHINGTON GATEWAY\8816 - GRAPHICS.DWG

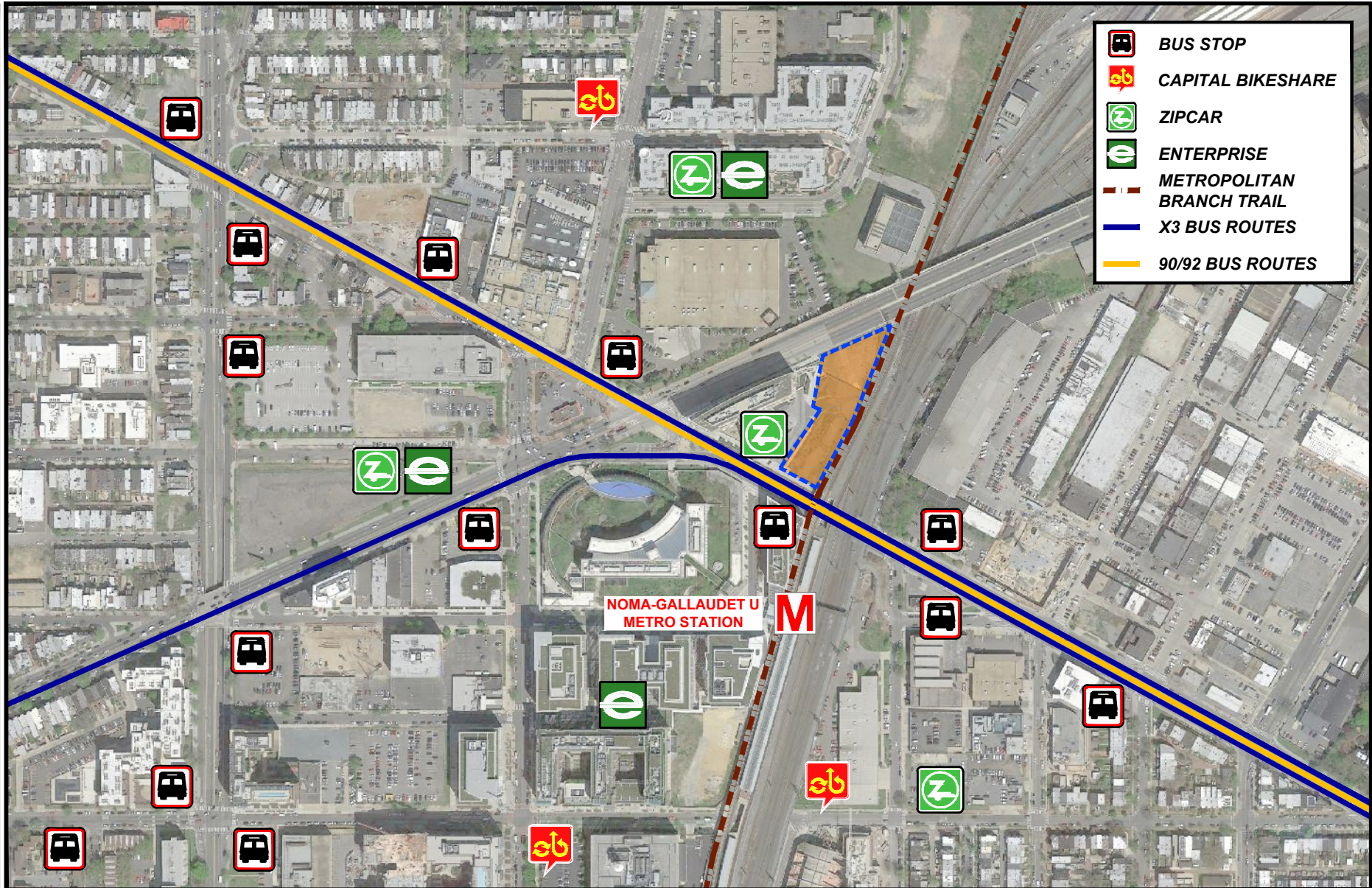

Figure □
Alternative Modes of Transportation

Washington Gateway
Washington, DC

CP



ZONING COMMISSION
District of Columbia
CASE NO.06-14D
EXHIBIT NO.41A7

0:\PROJECTS\6500-7000\6816 - WASHINGTON GATEWAY\6816 - GRAPHICS.DWG

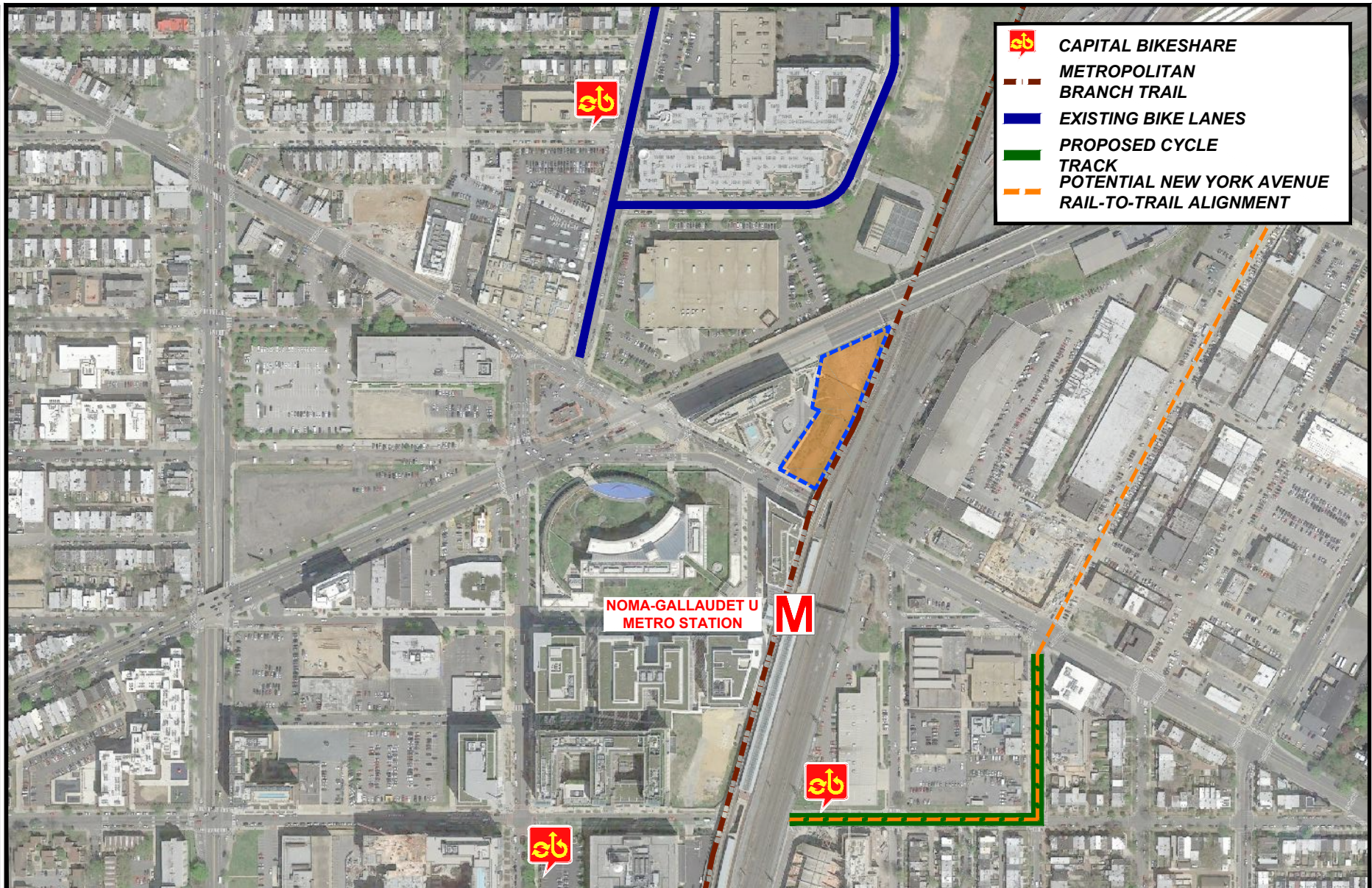

Figure 5
Bicycle Facilities and Infrastructure

Washington Gateway
Washington, DC

CP



0:\PROJ\CTS\6500-7000\8916 - WASHINGTON GATEWAY\8916 - GRAPHICS.DWG

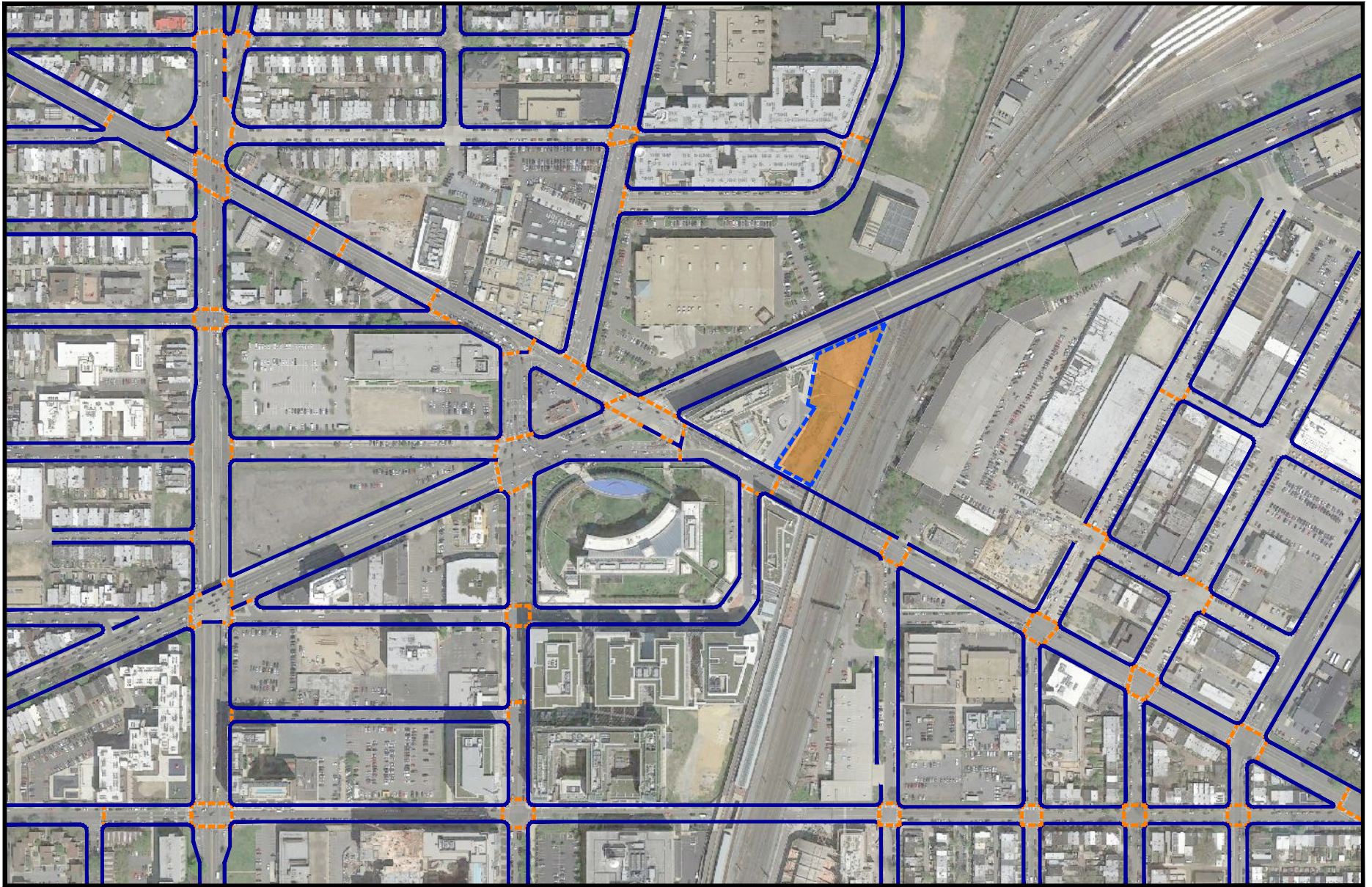

Figure 6
Pedestrian Facilities and Infrastructure

Washington Gateway
Washington, DC

- SIDEWALK
- - - CROSSWALK



CP

NEW YORK AVE NE



- ① PHASE 1 RESIDENTIAL BUILDING
- ② PHASE 1 ENTRY PLAZA
- ③ NORTH TOWER
- ④ SOUTH TOWER
- ⑤ RAIL CORRIDOR
- ⑥ METROPOLITAN BRANCH TRAIL
- ⑦ TRAIL CONNECTION LOBBY
- ⑧ EXISTING NY AVE STAIR CONNECTION



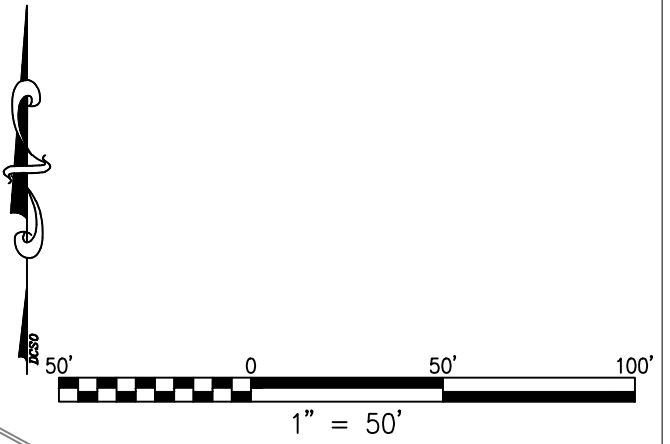
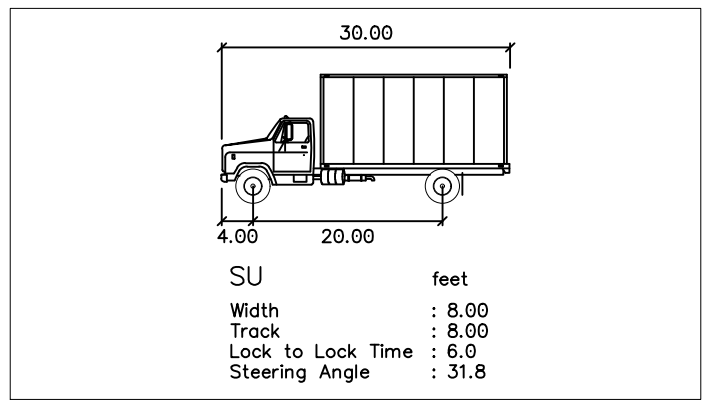
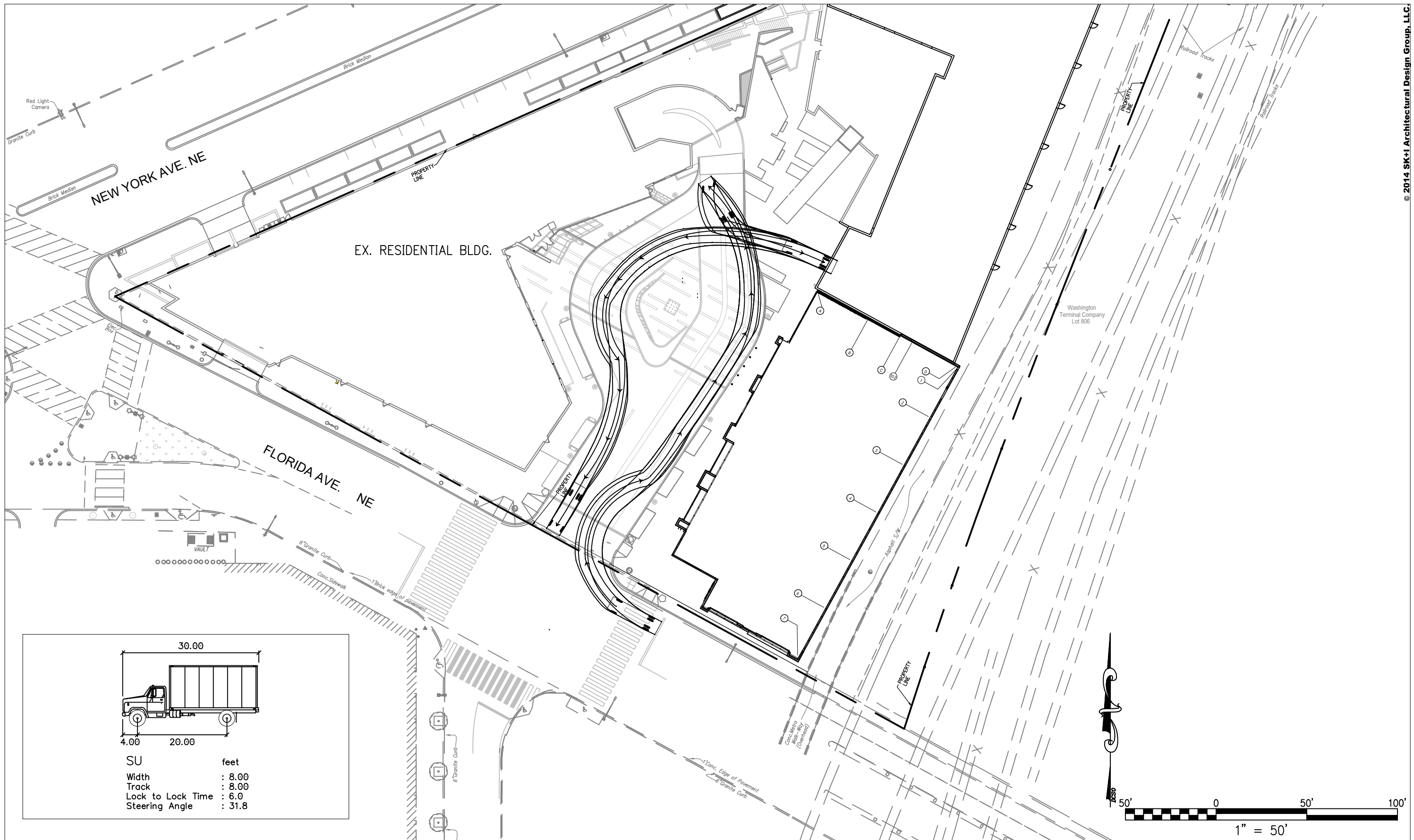

MRP | REALTY

Washington Gateway | Washington, DC

December 30, 2016 | C-601B







Truck Turning Plan SU

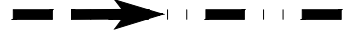

F:\2016\03_MaintGWDC\DC\ENR\GWDC\ENR\WG_PUD_Residential\Critical_Sheets\C-601_Trac_Turning.dwg, 12/29/2016 1:25:11 PM, jhan

LEGEND:

- VEHICULAR INBOUND 
- VEHICULAR OUTBOUND 
- LOADING DOCK MOVEMENTS 
- PEDESTRIANS 
- BIKES 

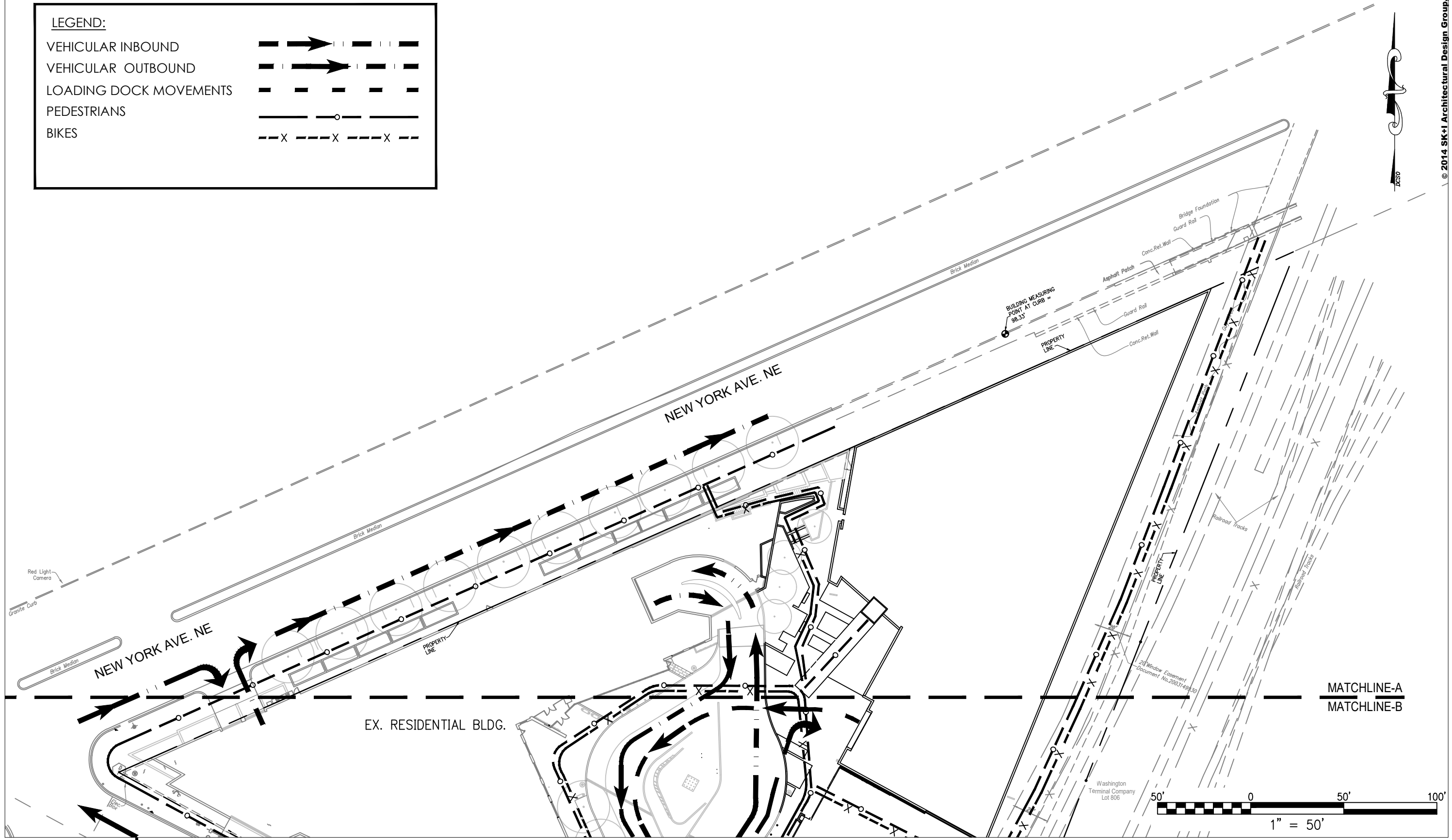

MRP | REALTY

Washington Gateway | Washington, DC

December 30, 2016 | C-602A



Circulation Plan A





MRP | REALTY

Washington Gateway | Washington, DC

February, 2014

SK+I
ARCHITECTURE

Appendix

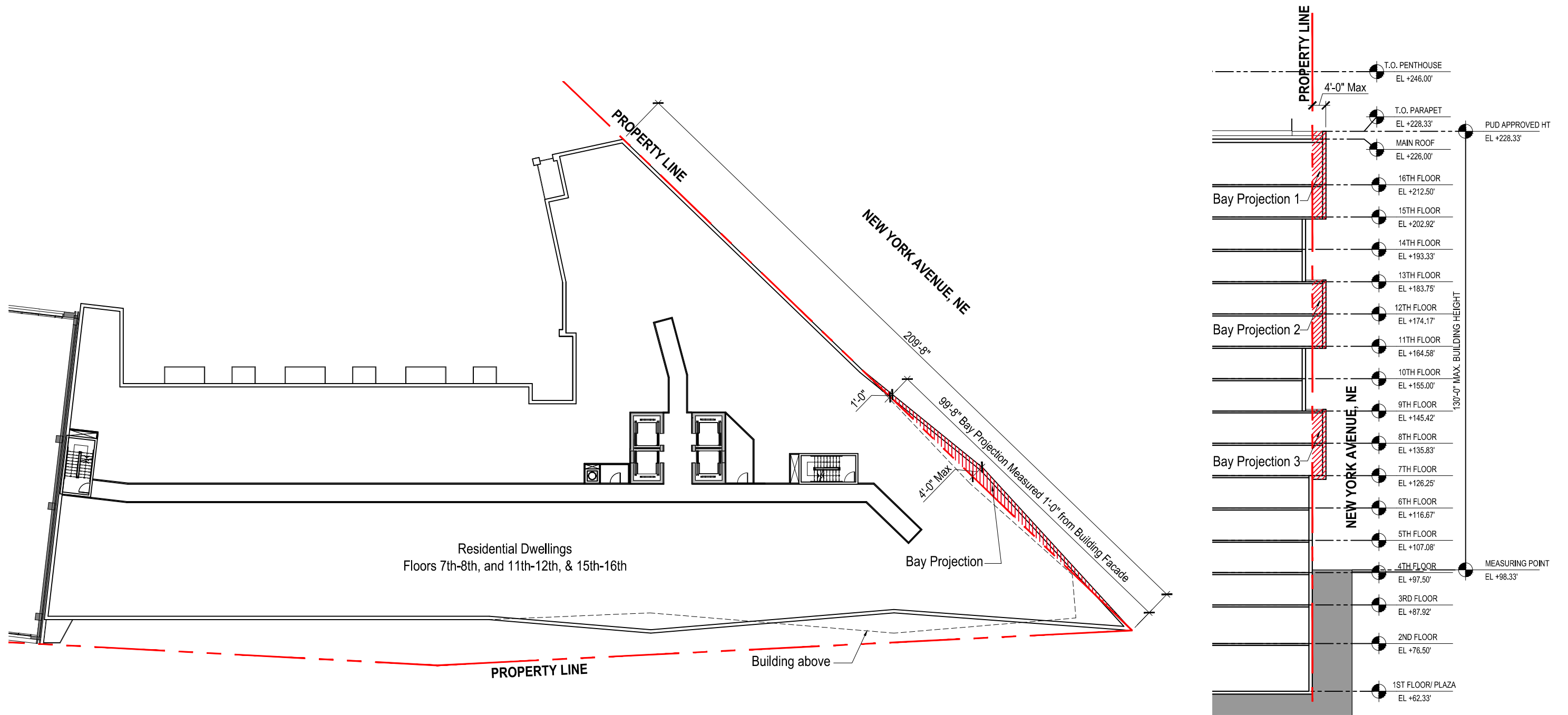

	Façade Width	Bay Projection Width (allowed)	Bay Projection Width (provided)	Bay Projection Depth (allowed)	Bay Projection Depth (provided)
New York Avenue	209'-8"	105'-10"	99'-8"	4'-0"	4'-0"

*Bay projection width is measured at a distance of 1'-0" from the building façade.

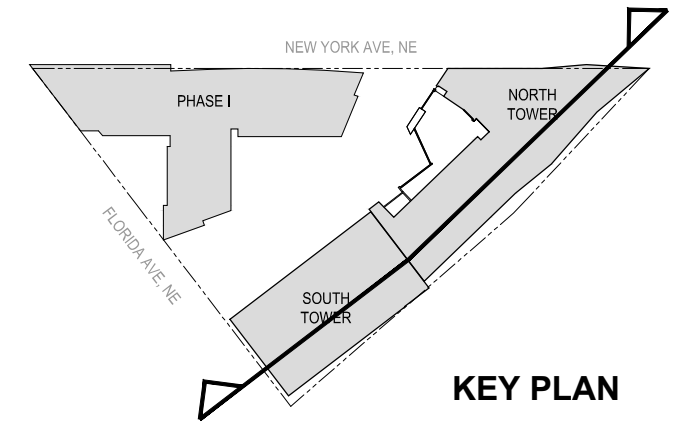
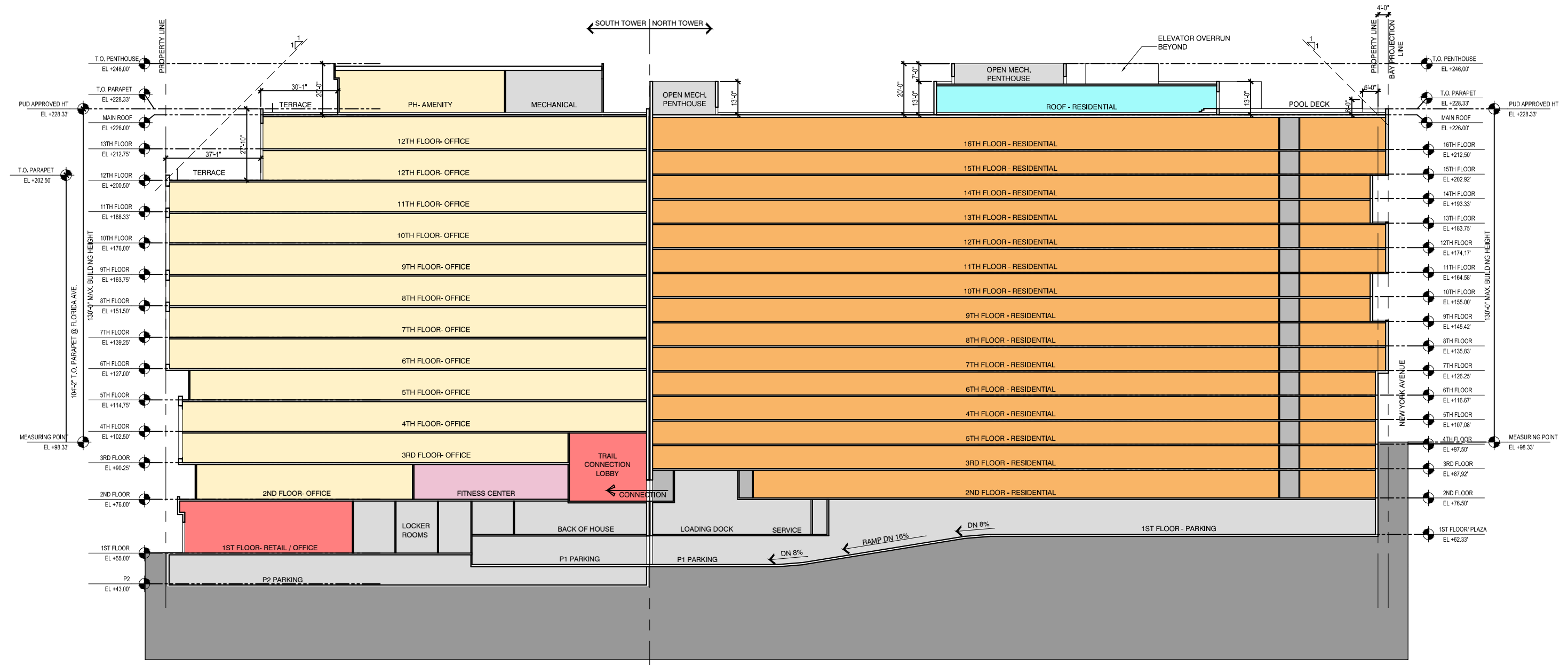

MRP | REALTY

Washington Gateway | Washington, DC

December 30, 2016 | A111



Architecture - Overall - Building Section

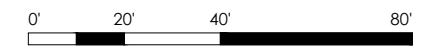

NEW YORK AVE NE



- ① NORTH TOWER POOL TERRACE
- ② NORTH TOWER ROOF TERRACE
- ③ NORTH TOWER AMENITY SPACE
- ④ SOUTH TOWER PENTHOUSE ROOF TERRACE
- ⑤ SOUTH TOWER LEVEL 12 ROOF TERRACE
- ⑥ SOUTH TOWER LEVEL 11 ROOF TERRACE
- ⑦ GREENROOF

