



BZA Application No. 20798

117 12th Street, SE
Eric & Elizabeth Paisner
November 2, 2022

Board of Zoning Adjustment
District of Columbia
CASE NO.20798
EXHIBIT NO.32

Sullivan & Barros, LLP

Overview and Requested Relief

- Alley lot development.
- The Applicant is proposing to demolish the existing shed and construct a new two-story, single-family dwelling on an alley lot. The Applicant intends to use the first floor as a two-car garage and the second floor as a residential dwelling unit.
- To complete the project, the Applicant is requesting special exception relief from;
 - The new-alley-record-lot requirements (pre-2016 tax lot)
 - The rear yard requirements (5 ft. required, 0 ft. proposed)
 - The side yard requirements (5 ft. required, 0 ft. proposed)
 - The alley centerline setback requirements (2.5 ft. required, 0 ft. proposed)
 - *Pervious surface request was withdrawn due to the provision of a green roof.*

Community and Agency Support

- ANC 6B voted unanimously in support.
- The Office of Planning recommends approval.
- DDOT has no objection.
- There are 4 letters of support, including the adjacent neighbor to the south.





Subj. Property
117 12th St., SE



Subj. Property
117 12th St., SE



Subj. Property
117 12th St., SE



PAISNER RESIDENCE

117 12TH ST SE, LOT 807, WASHINGTON, D.C. 20003

PROJECT DATA

OWNER:	PAISNER, ERIC J. AND PAISNER, ELIZABETH P.
EXISTING	RESIDENTIAL-GARAGE
PROPOSED	RESIDENTIAL-SINGLE-FAMILY-DETACHED
PROJECT DESCRIPTION	CONSTRUCTION OF A NEW, SINGLE FAMILY, TWO STORY DETACHED RESIDENCE

ZONING DATA

SQUARE / LOT	0989 / 0807	
ZONE	RF-1	
USE GROUP	R-3	
CONSTRUCTION TYPE	VB	
STORIES	EXISTING	PROPOSED
LOT SIZE	1	2
LOT OCCUPANCY	532 SF	NO CHANGE
	135 SF / 25.4%	532 / 100%

VICINITY MAP

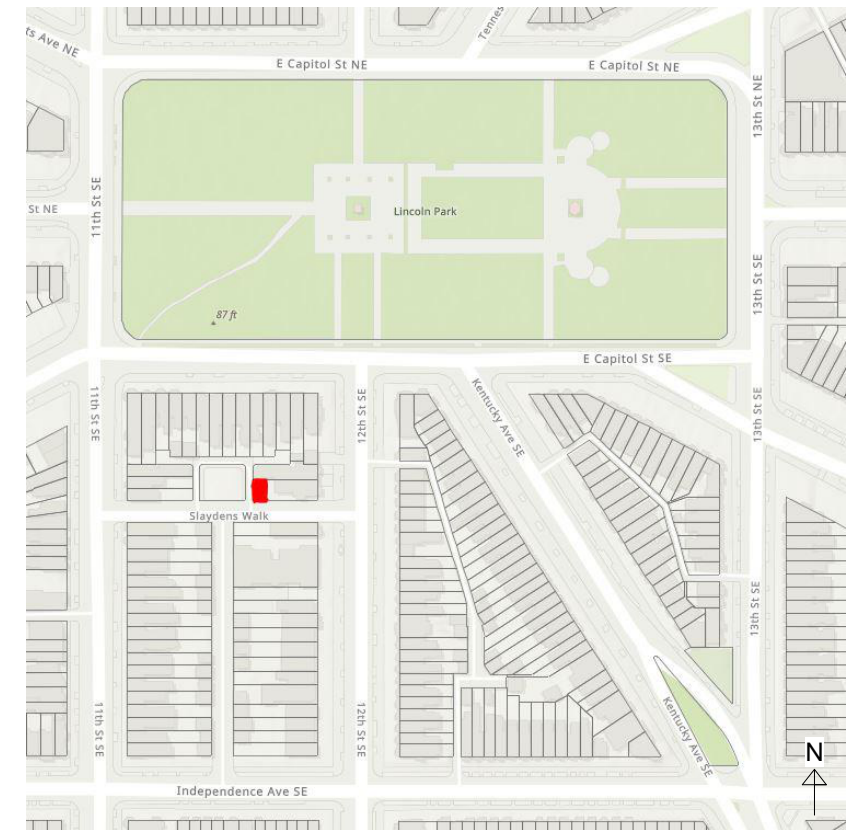

PROJECT TEAM

ARCHITECT
EUSTILUS LLC
ERIC TERAN
2800 N. ROSSER ST
ALEXANDRIA, VA 22311
202-569-9620
ETERAN@EUSTILUS.COM

SHEET INDEX

01	COVER
02	SITE PLAN
03	FLOOR PLANS
04	ELEVATIONS
05	SECTIONS
06	EXISTING & DEMO PLANS
07	PARKING DIAGRAM

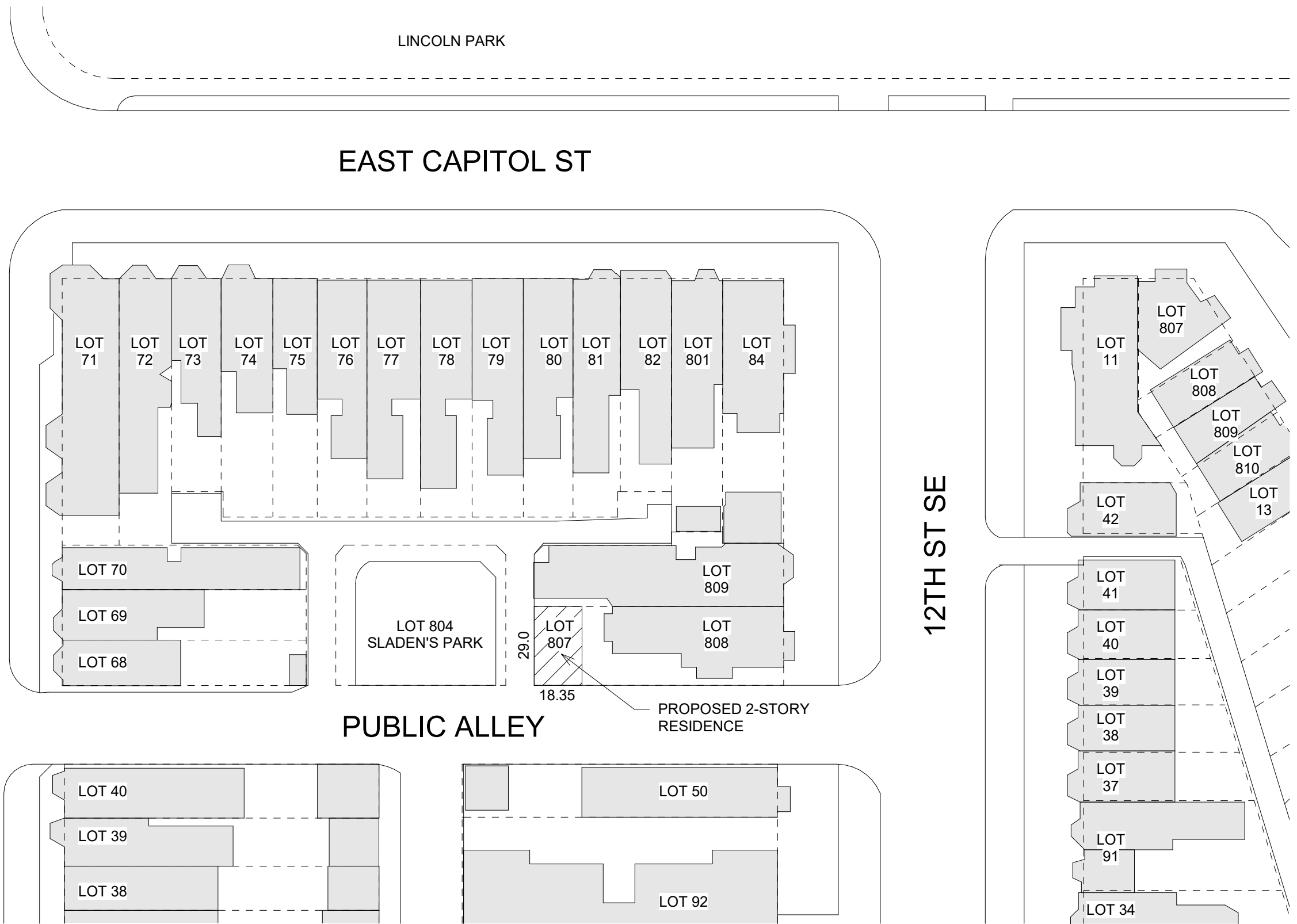
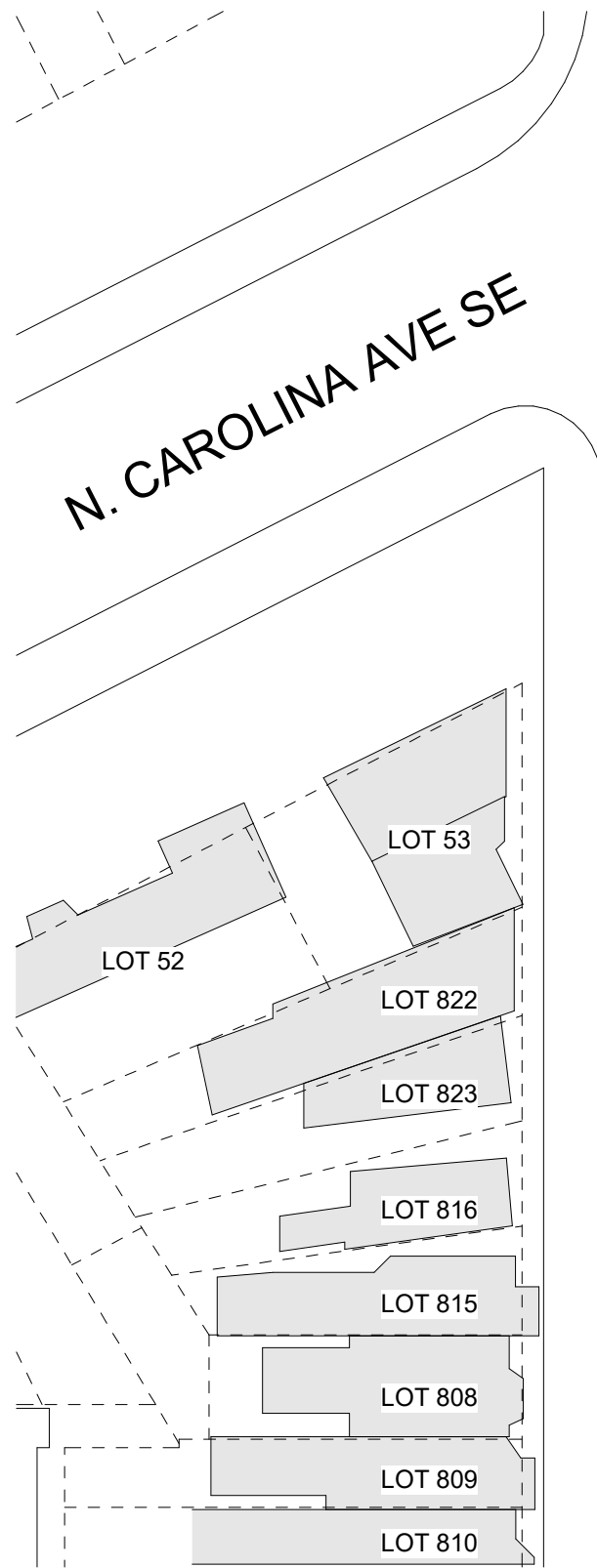

PAISNER RESIDENCE

SITE PLAN



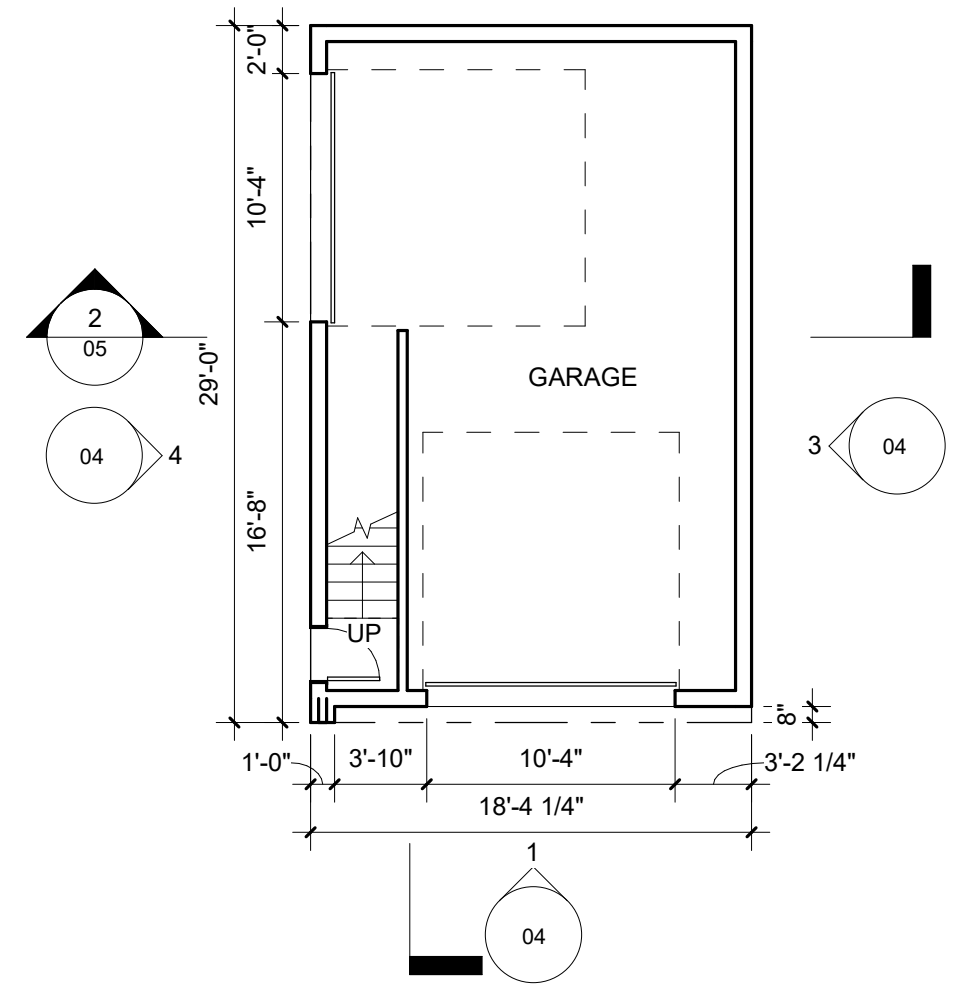
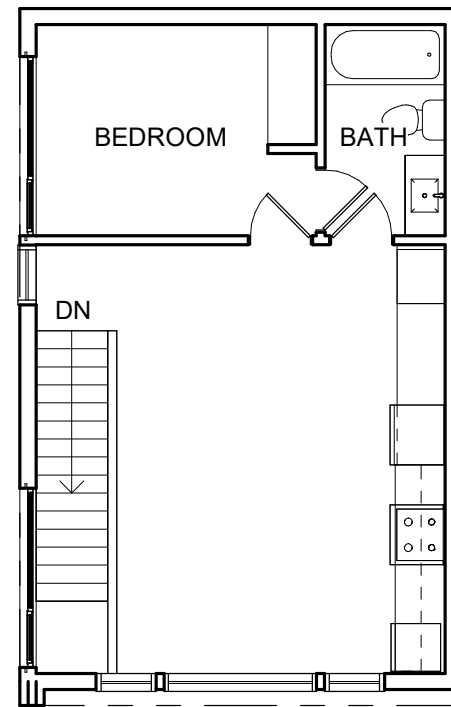
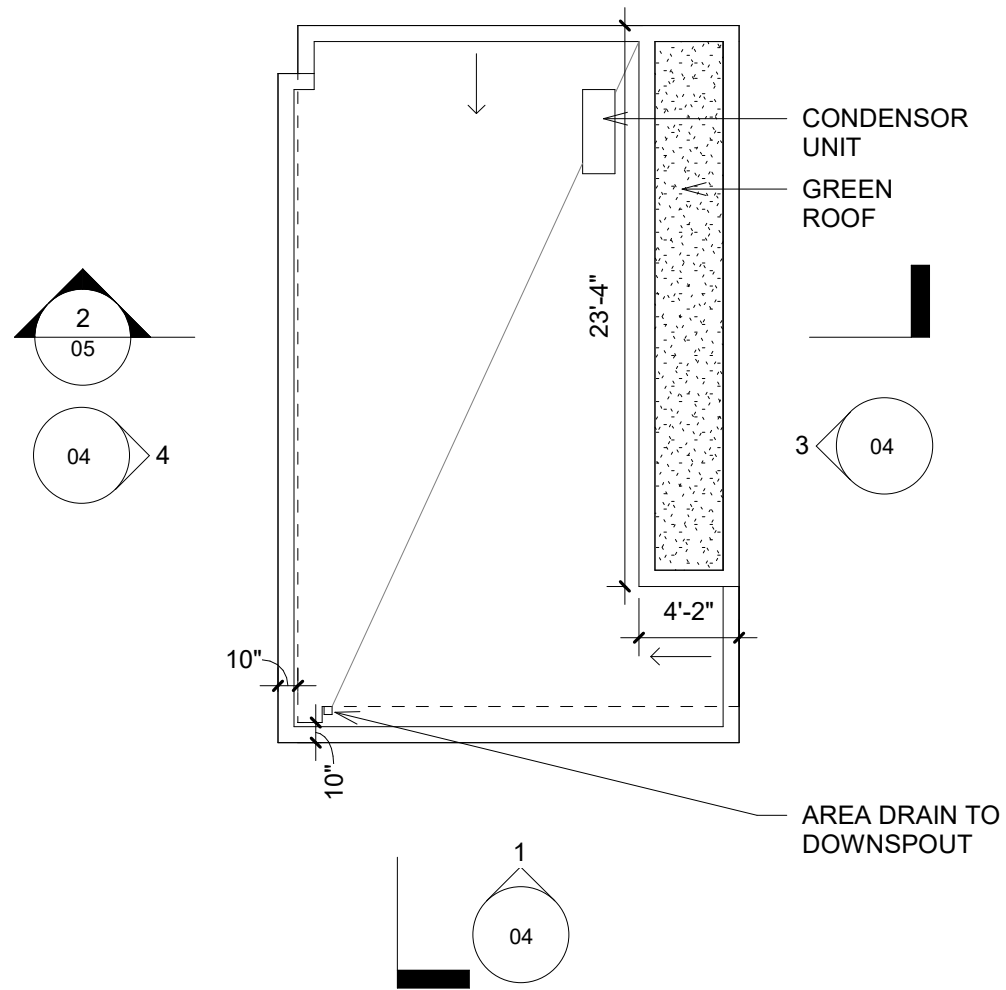
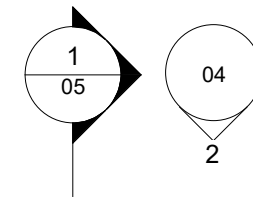
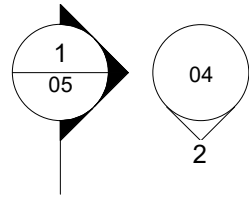
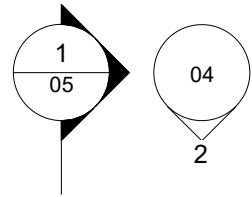

3 ROOF
1/8" = 1'-0"

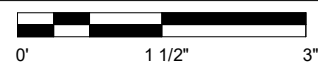

2 LEVEL 02
1/8" = 1'-0"

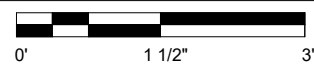

1 LEVEL 01
1/8" = 1'-0"



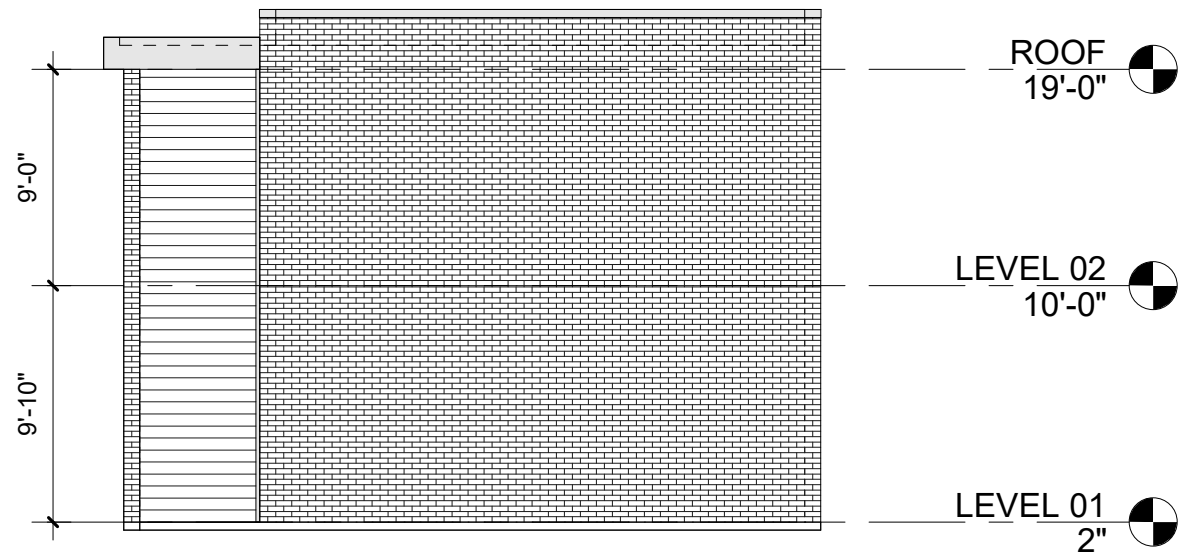

3 EAST ELEVATION

1/8" = 1'-0"

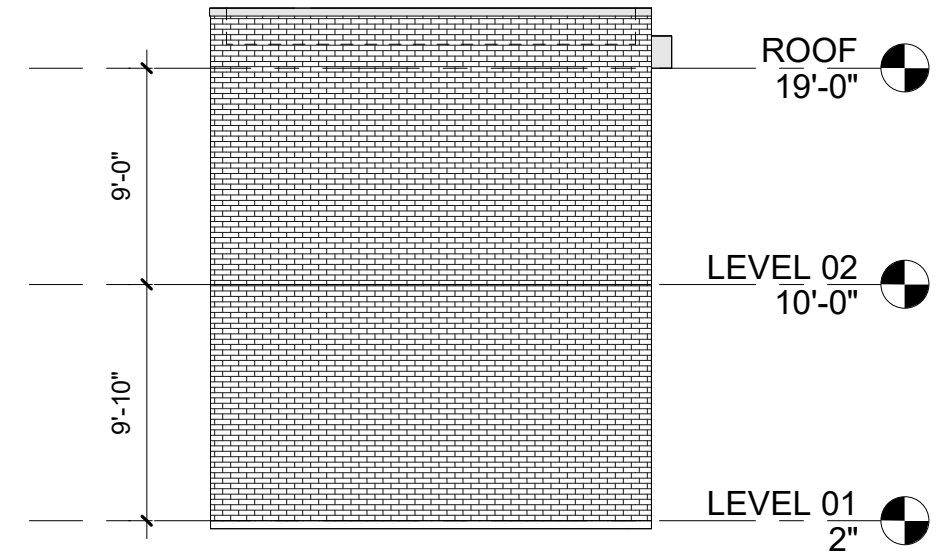
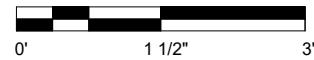

2 NORTH ELEVATION

1/8" = 1'-0"

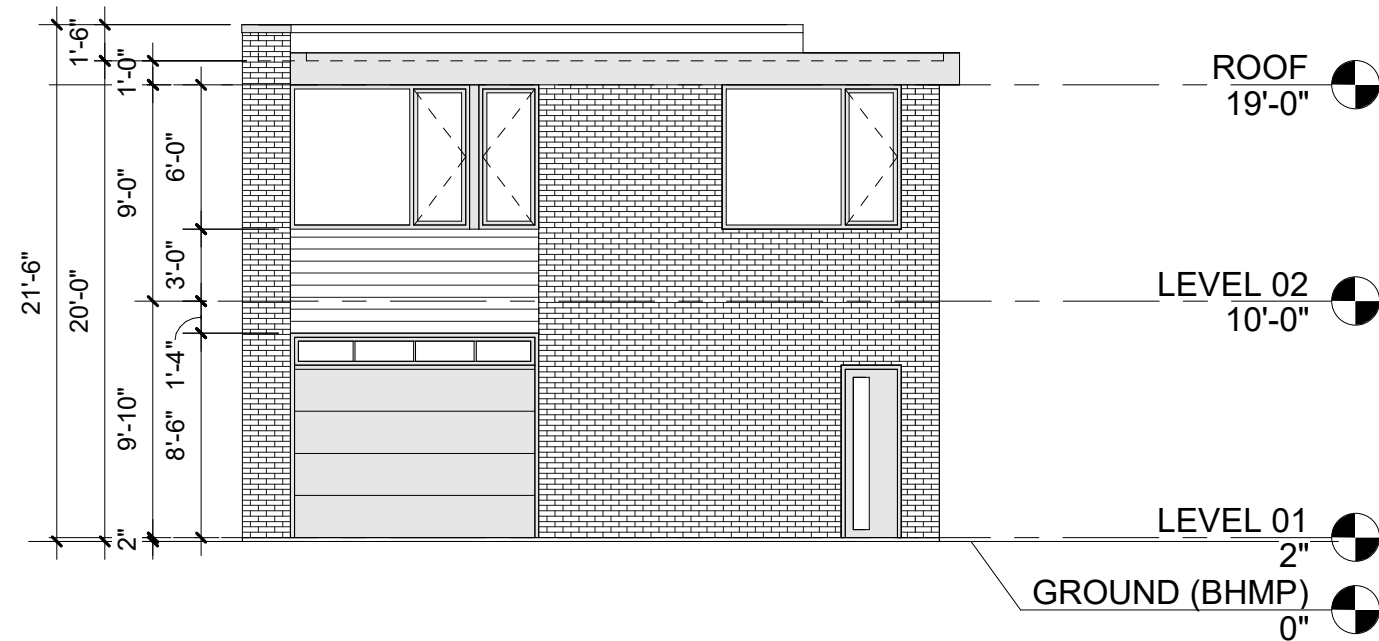

4 WEST ELEVATION

1/8" = 1'-0"

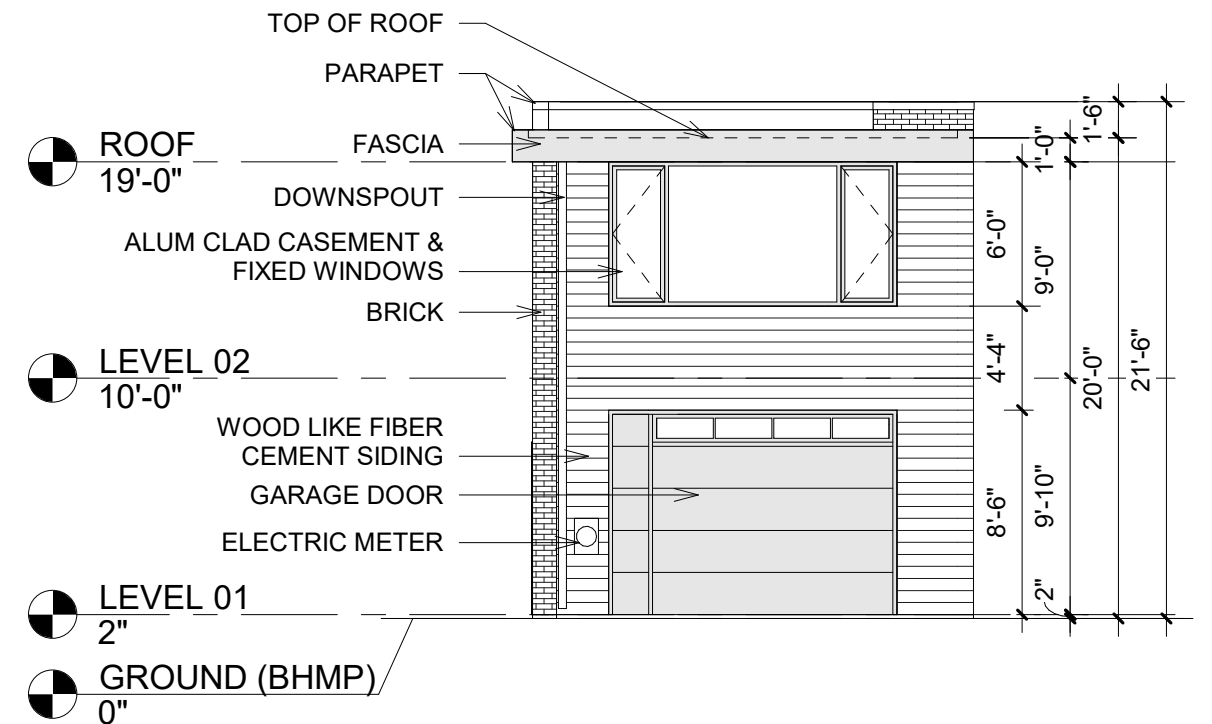
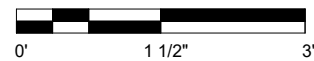

1 SOUTH ELEVATION

1/8" = 1'-0"

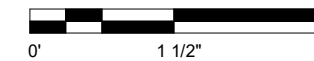

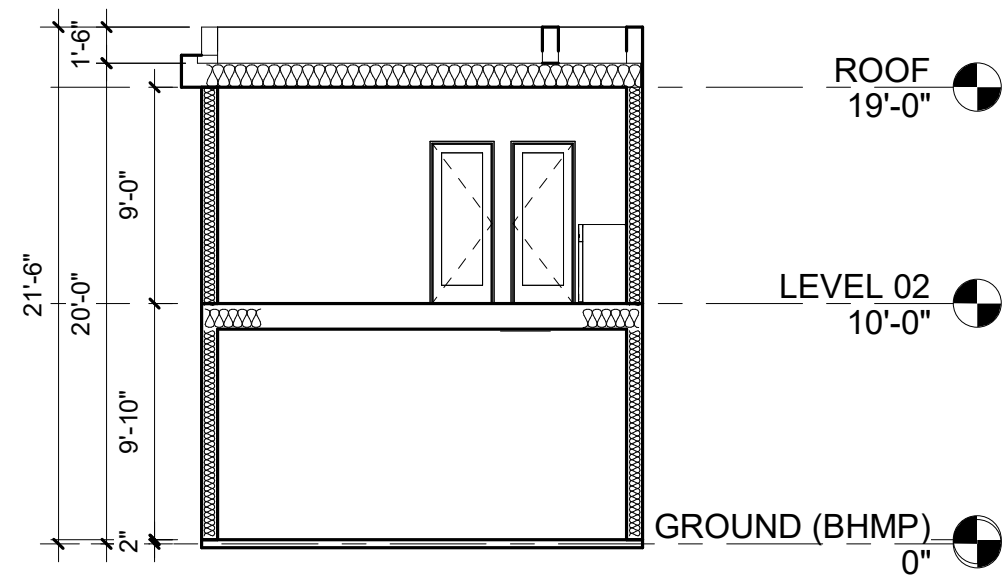

2 WEST-EAST SECTION
 1/8" = 1'-0"
 0' 1 1/2" 3"

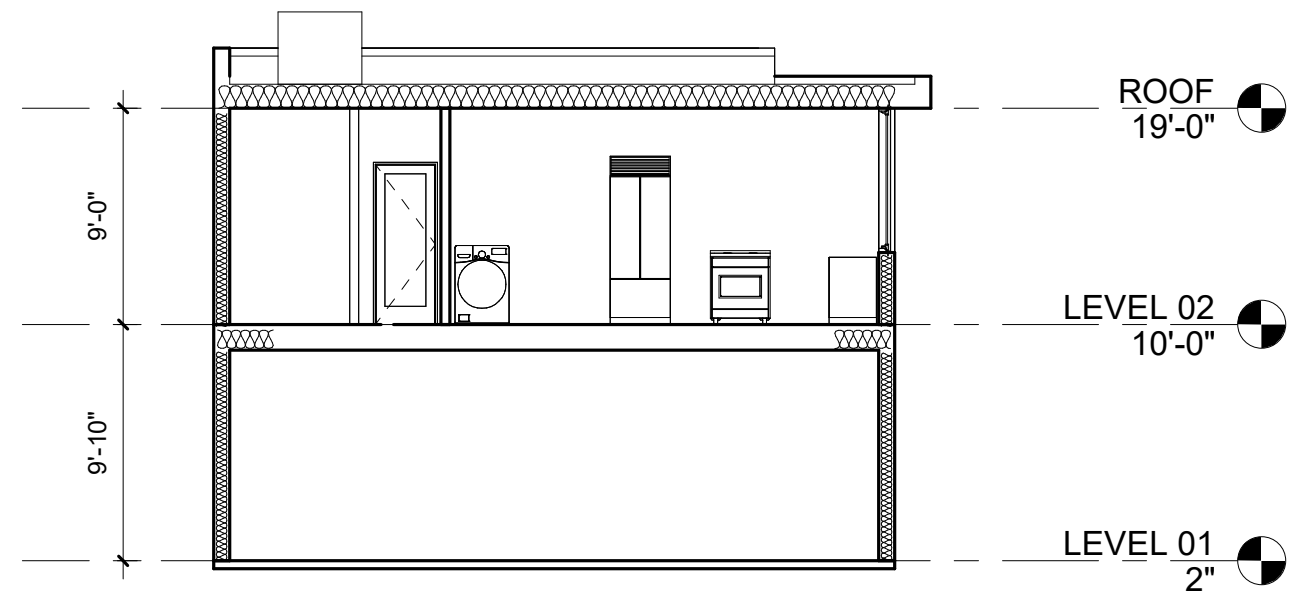

1 NORTH-SOUTH SECTION
 1/8" = 1'-0"
 0' 1 1/2" 3"

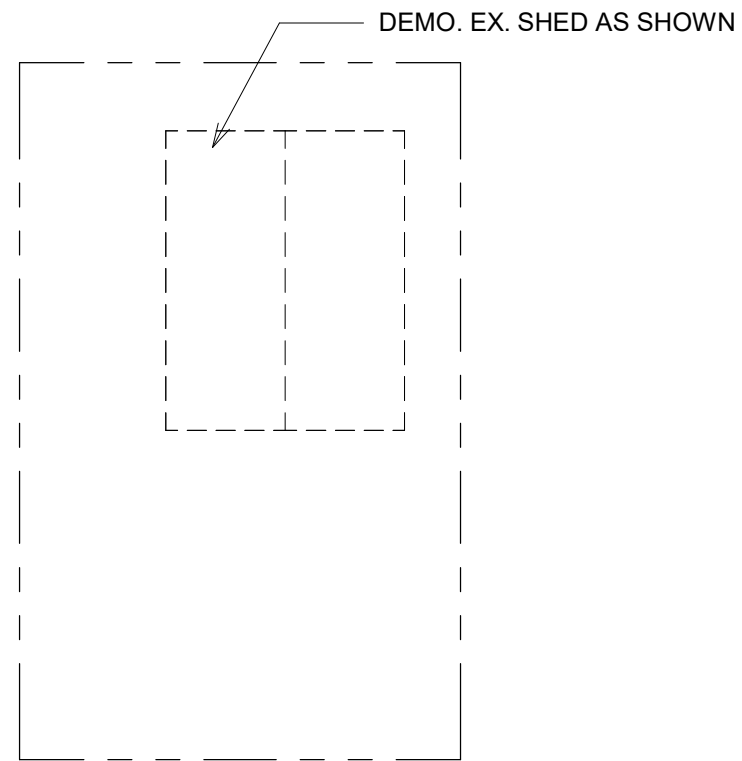

2 ROOF - DEMOLITION
 1/8" = 1'-0"
 0' 1 1/2" 3"
 N

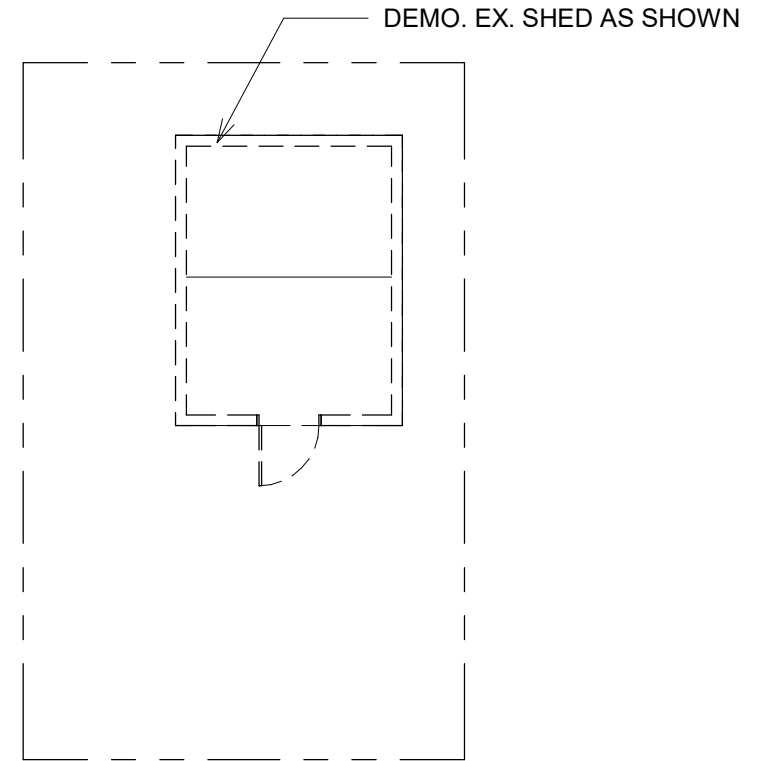

1 LEVEL 01 - DEMOLITION
 1/8" = 1'-0"
 0' 1 1/2" 3"
 N

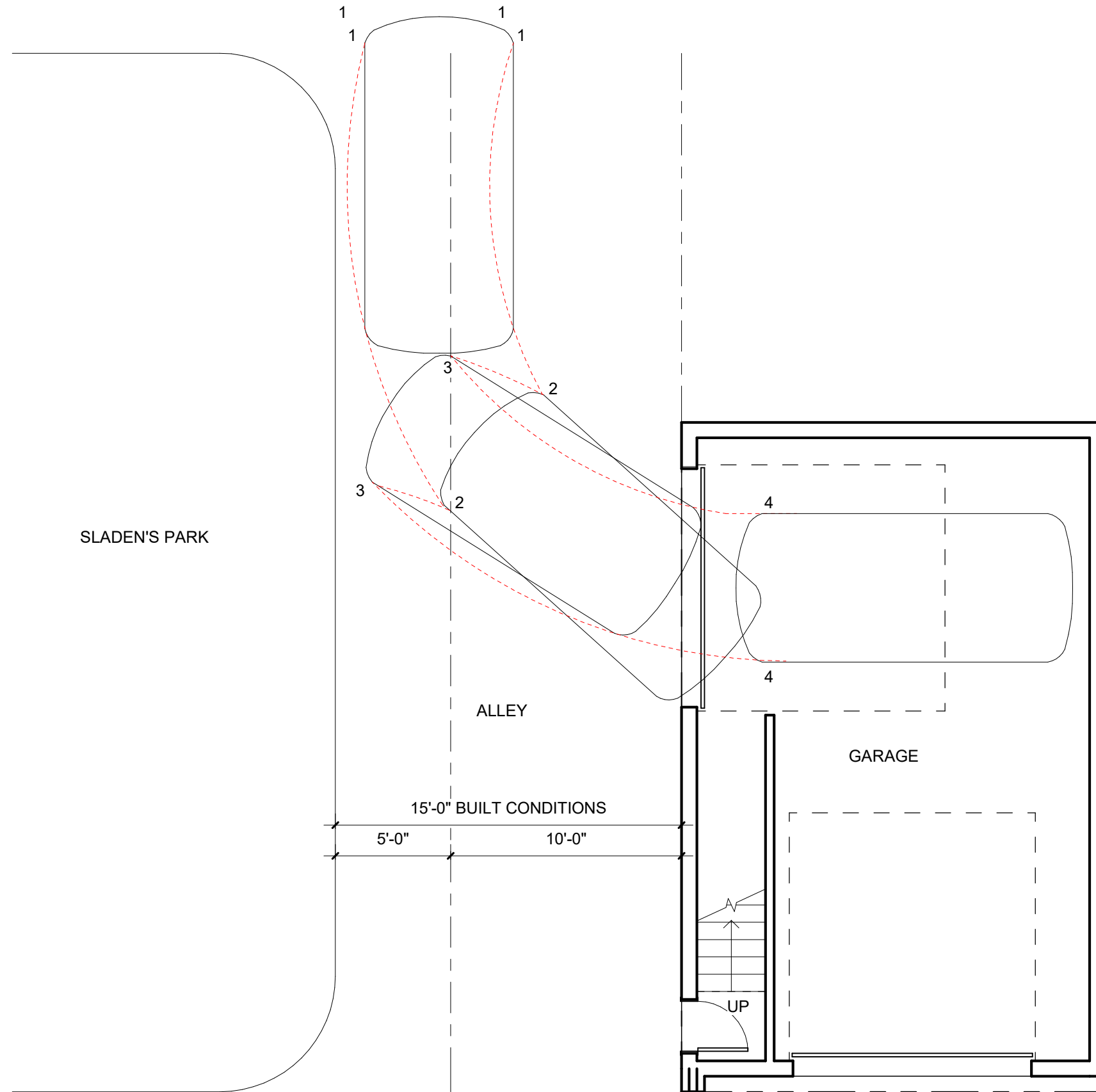

----- MATTER OF RIGHT

█ PROPOSED

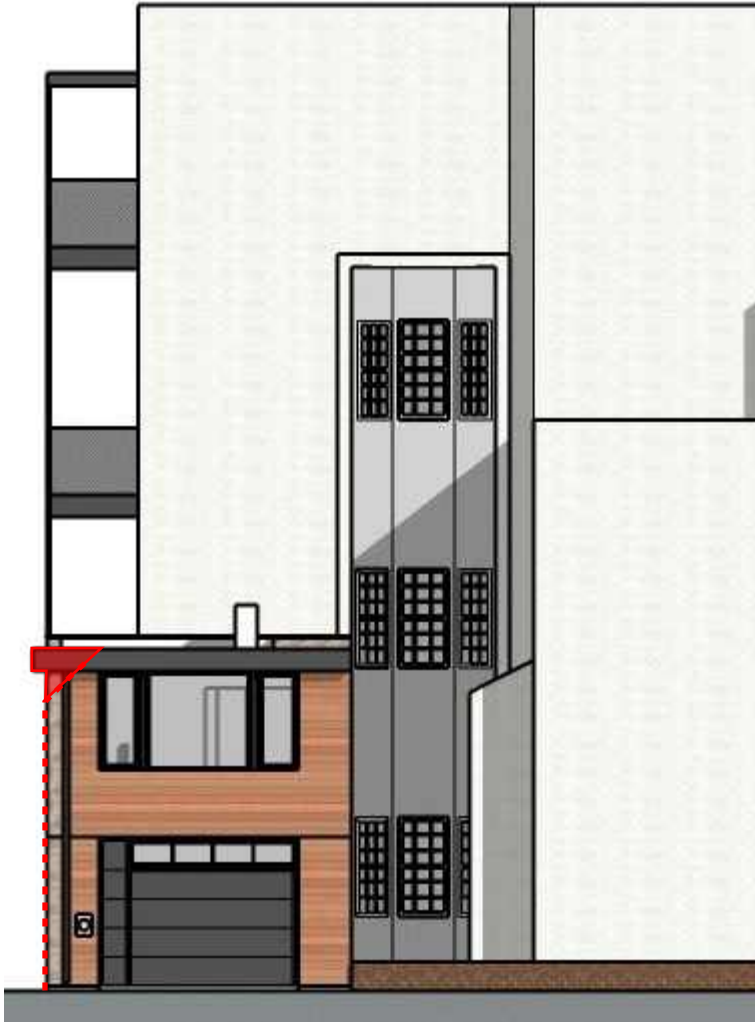

PROPOSED

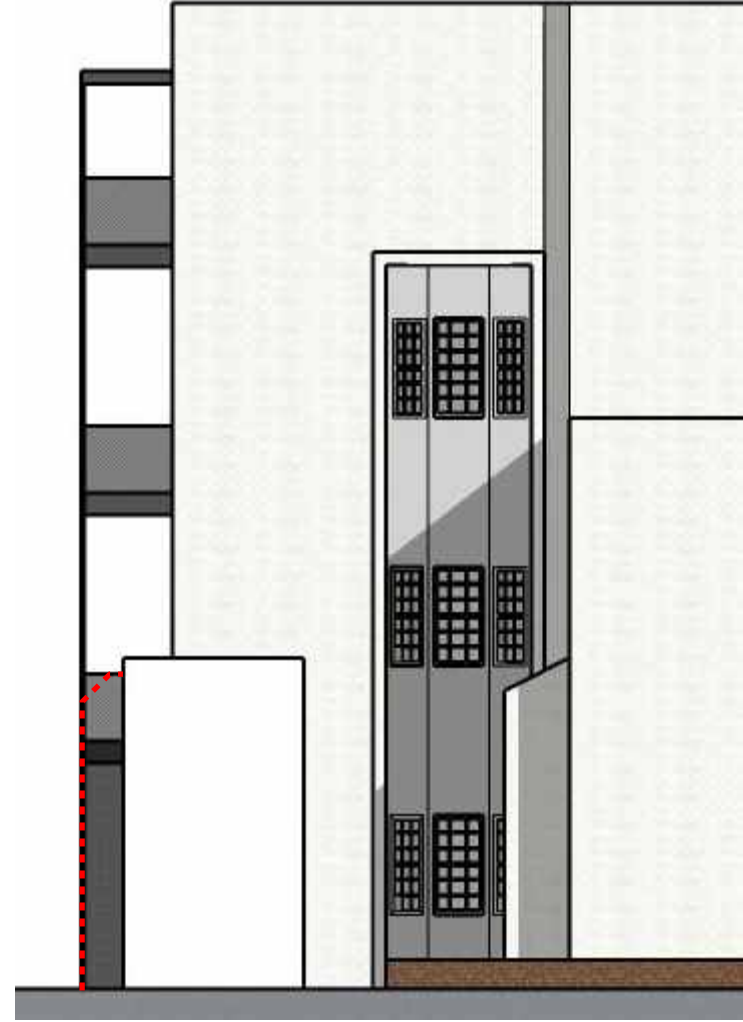

MATTER OF RIGHT

PAISNER RESIDENCE

117 12TH ST SE, LOT 807, WASHINGTON, D.C. 20003

WINTER SOLSTICE 9:00 AM

EUSTILUS

----- MATTER OF RIGHT

■ PROPOSED

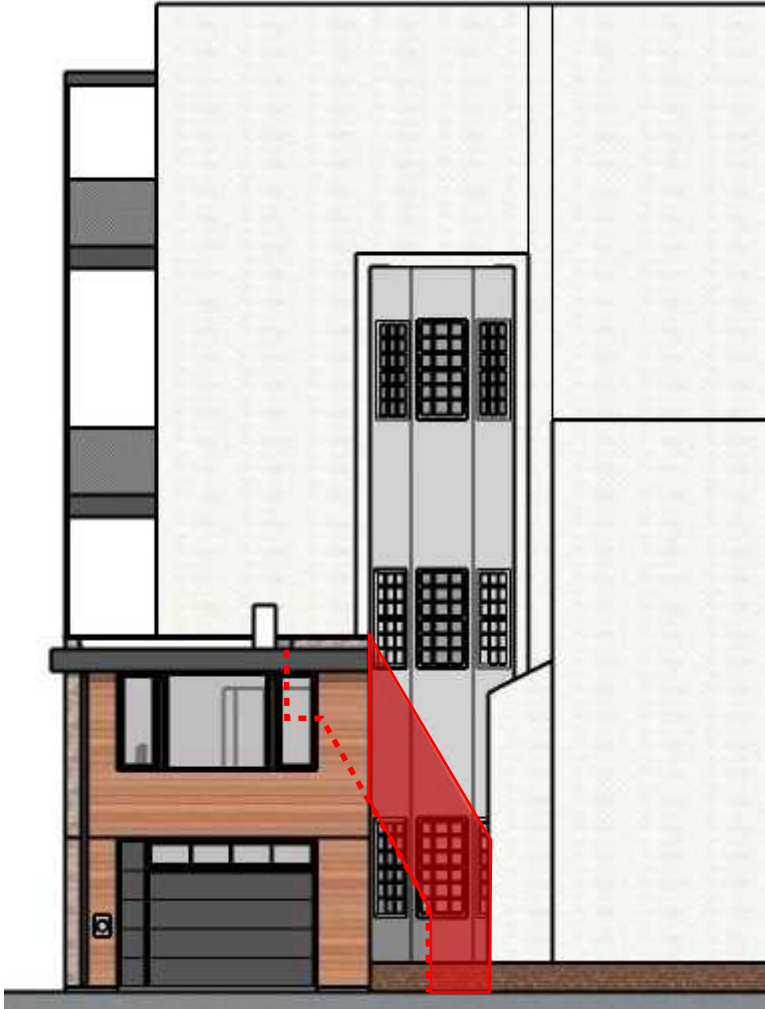

PROPOSED

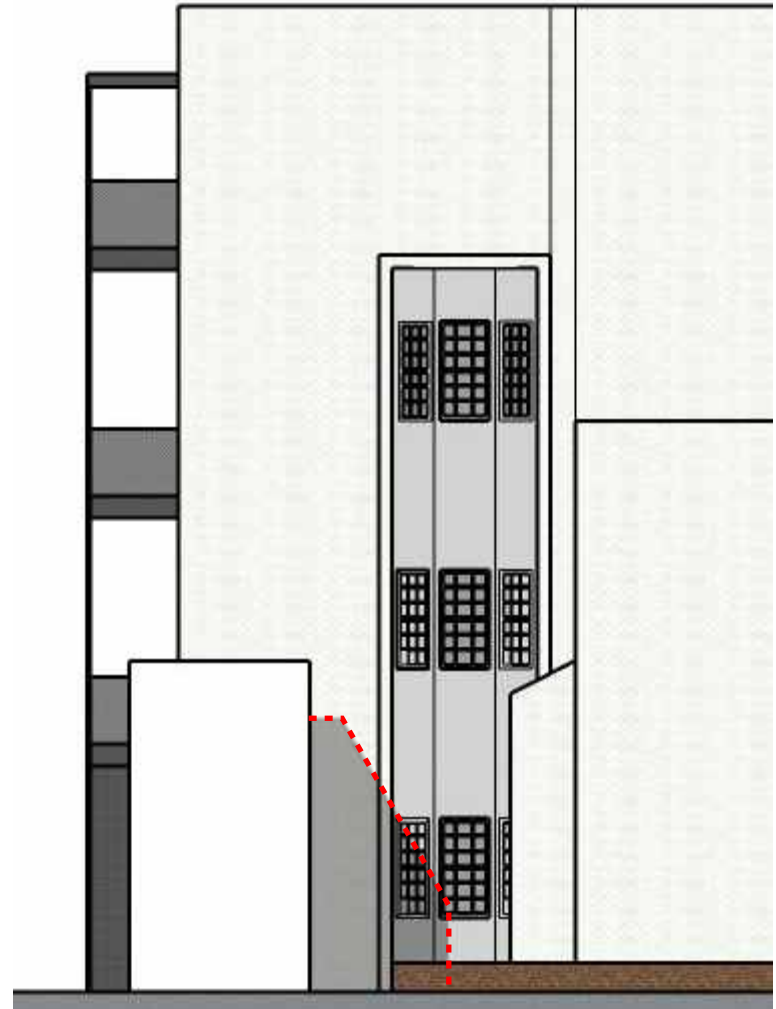

MATTER OF RIGHT

PAISNER RESIDENCE

117 12TH ST SE, LOT 807, WASHINGTON, D.C. 20003

WINTER SOLSTICE 12:00 PM

EUSTILUS

----- MATTER OF RIGHT

█ PROPOSED

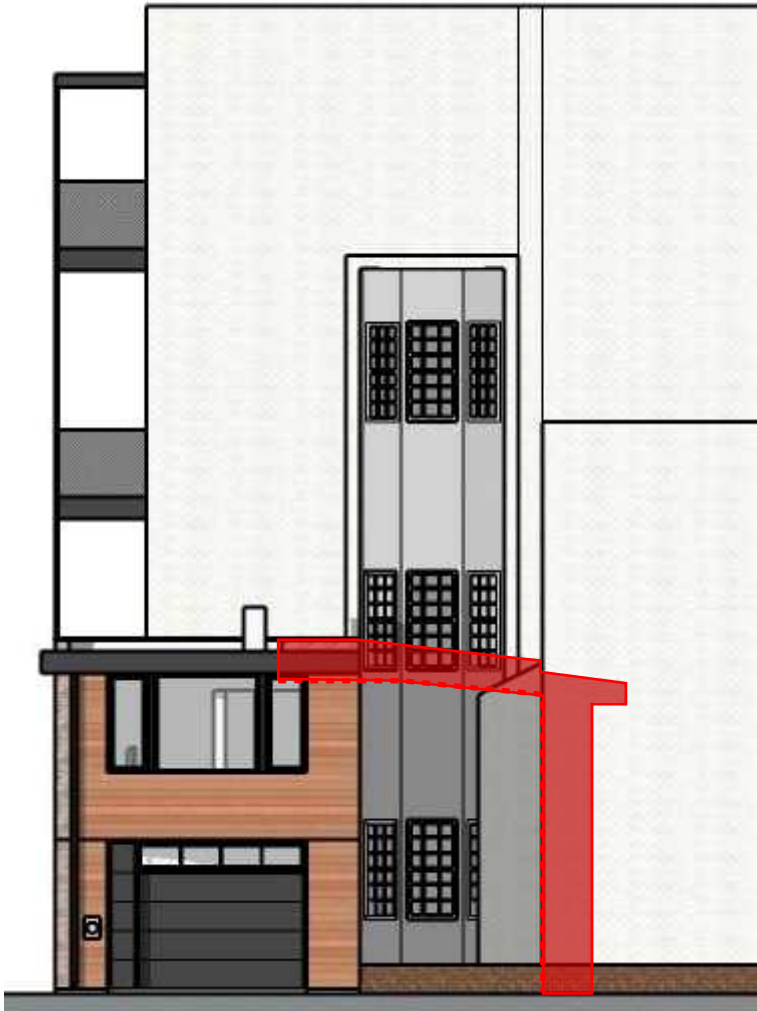

PROPOSED

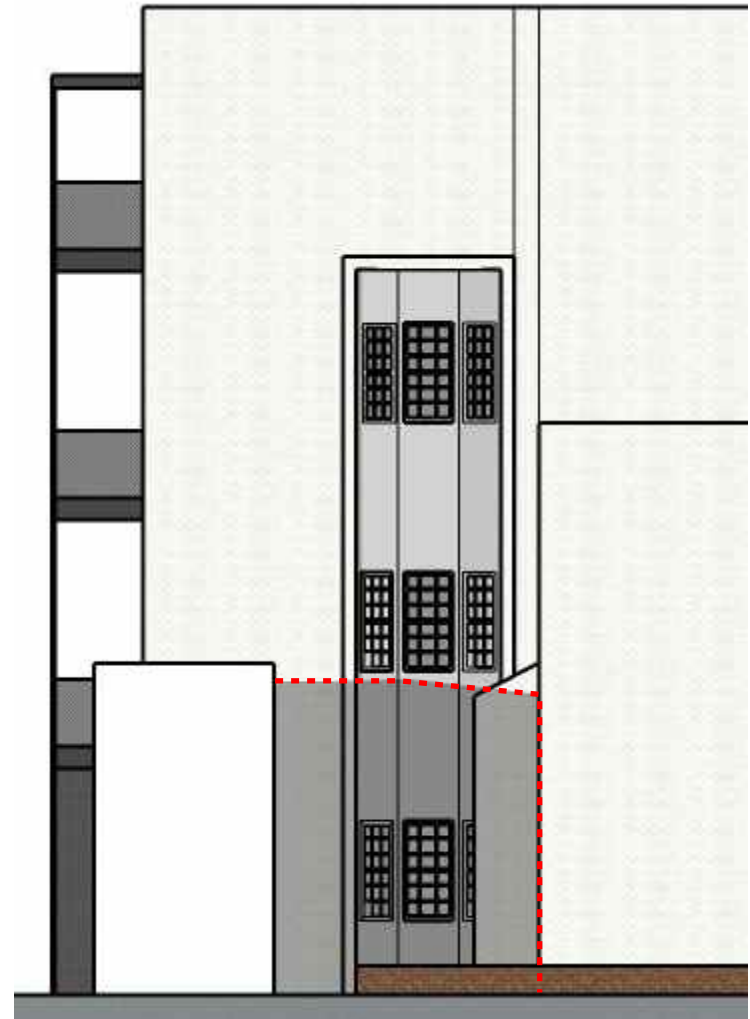

MATTER OF RIGHT

PAISNER RESIDENCE

117 12TH ST SE, LOT 807, WASHINGTON, D.C. 20003

WINTER SOLSTICE 3:00 PM

EUSTILUS

----- MATTER OF RIGHT

█ PROPOSED

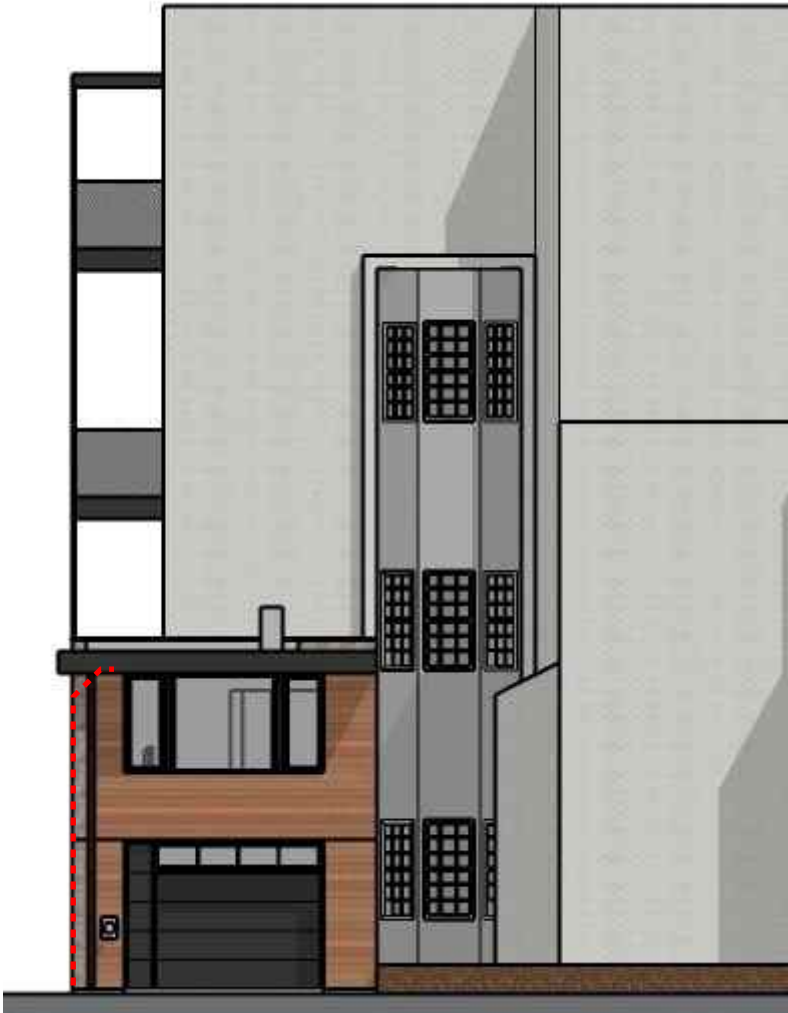

PROPOSED

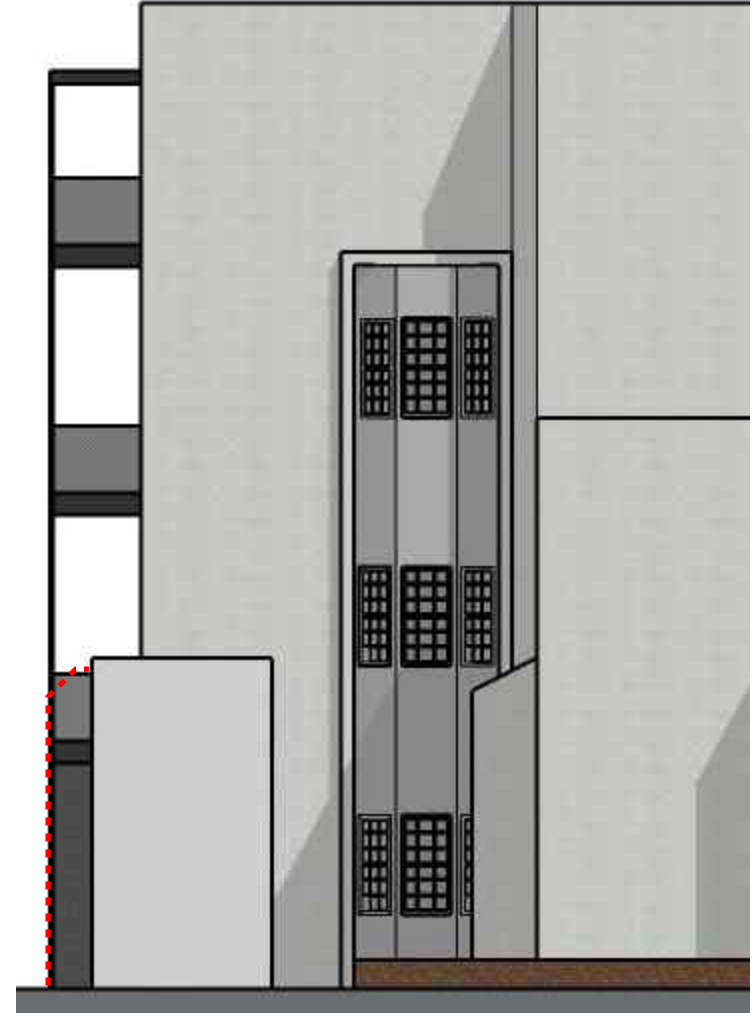

MATTER OF RIGHT

PAISNER RESIDENCE

117 12TH ST SE, LOT 807, WASHINGTON, D.C. 20003

SUMMER SOLSTICE 9:00 AM

EUSTILUS

----- MATTER OF RIGHT

█ PROPOSED

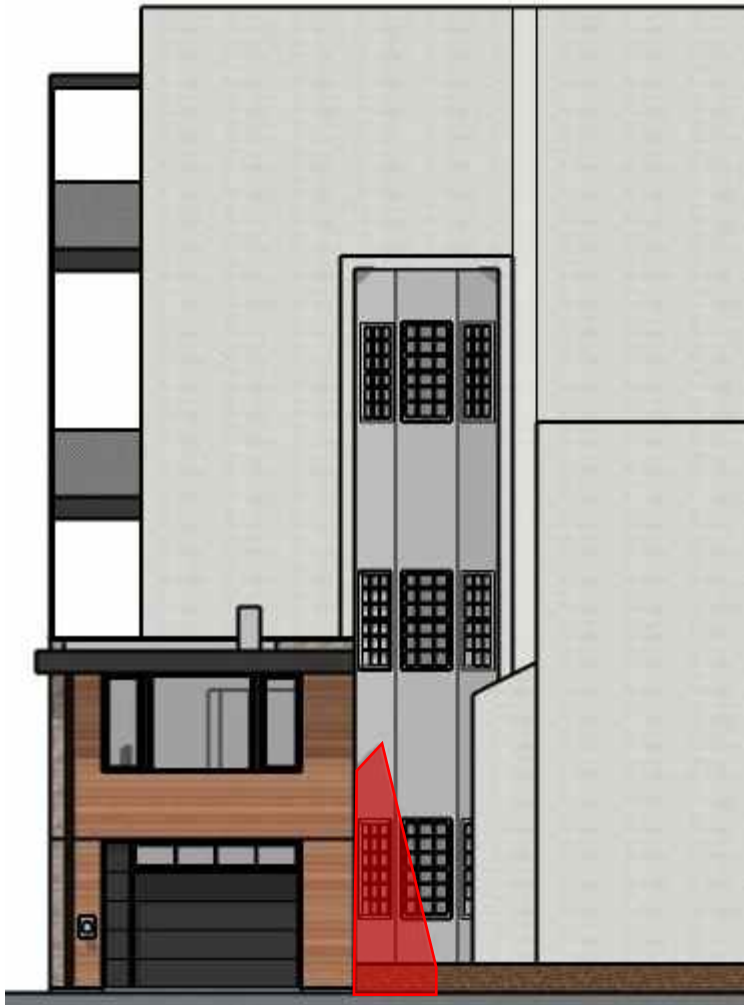

PROPOSED

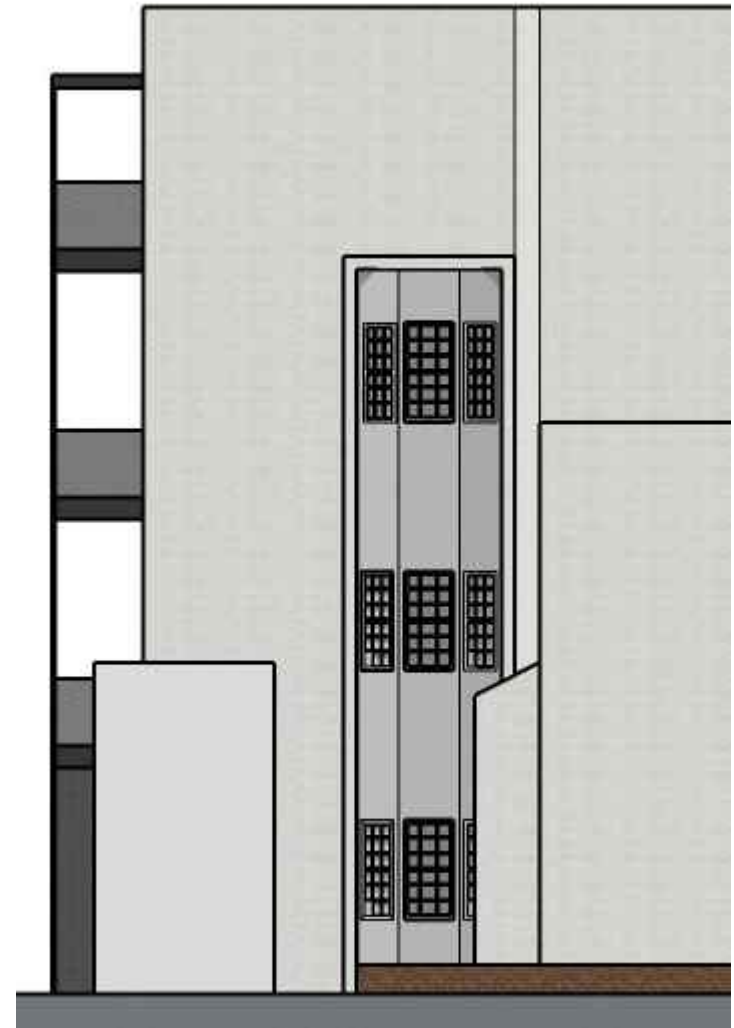

MATTER OF RIGHT

PAISNER RESIDENCE

117 12TH ST SE, LOT 807, WASHINGTON, D.C. 20003

SUMMER SOLSTICE 12:00 PM

EUSTILUS

----- MATTER OF RIGHT

█ PROPOSED

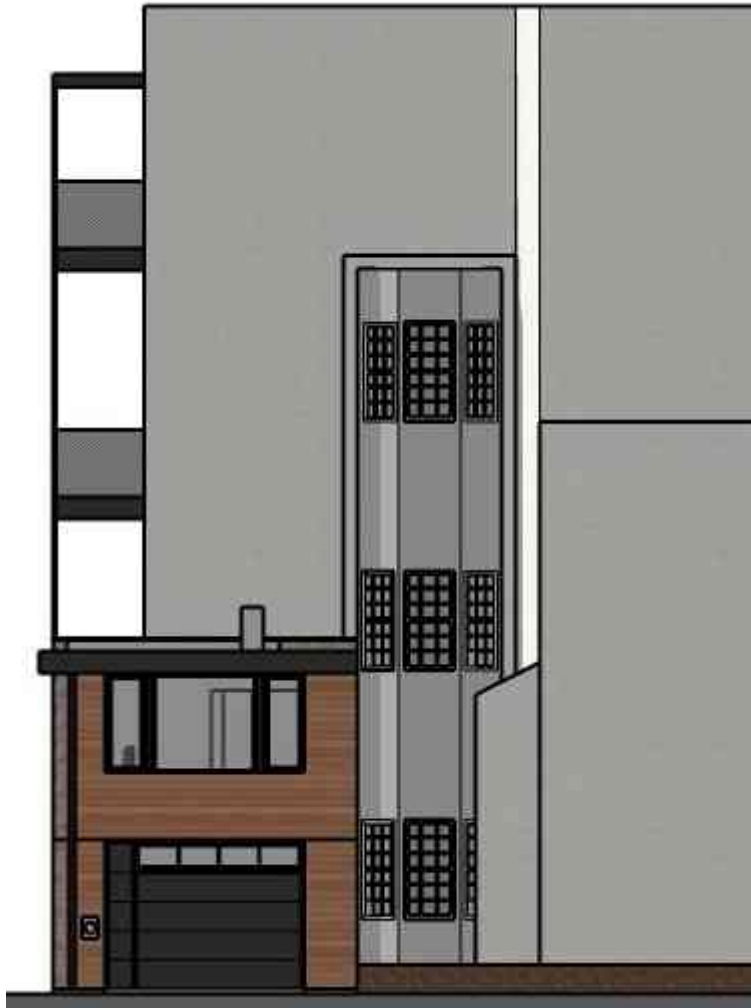

PROPOSED

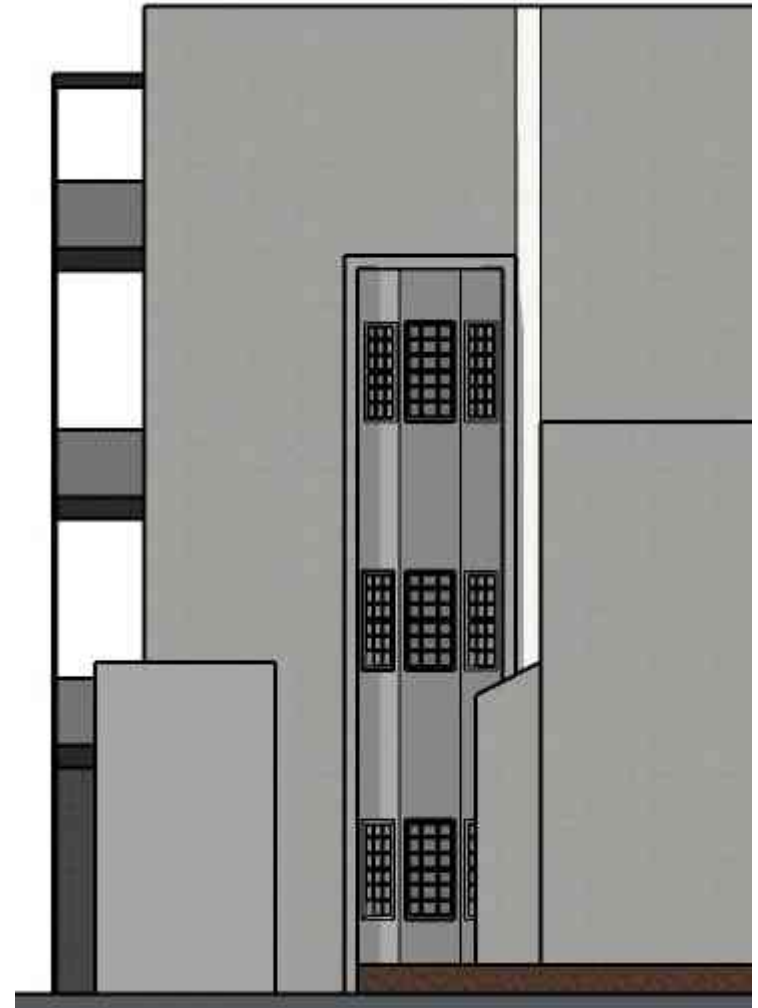

MATTER OF RIGHT

PAISNER RESIDENCE

SUMMER SOLSTICE 3:00 PM

----- MATTER OF RIGHT

█ PROPOSED

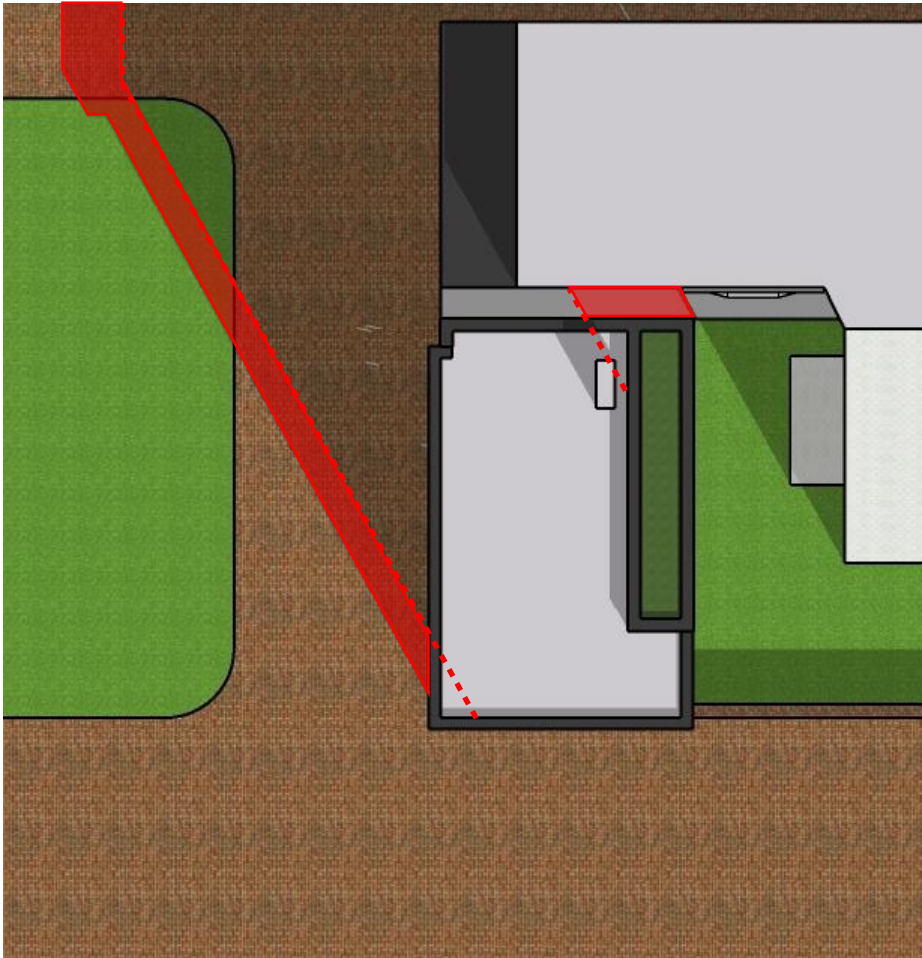

PROPOSED

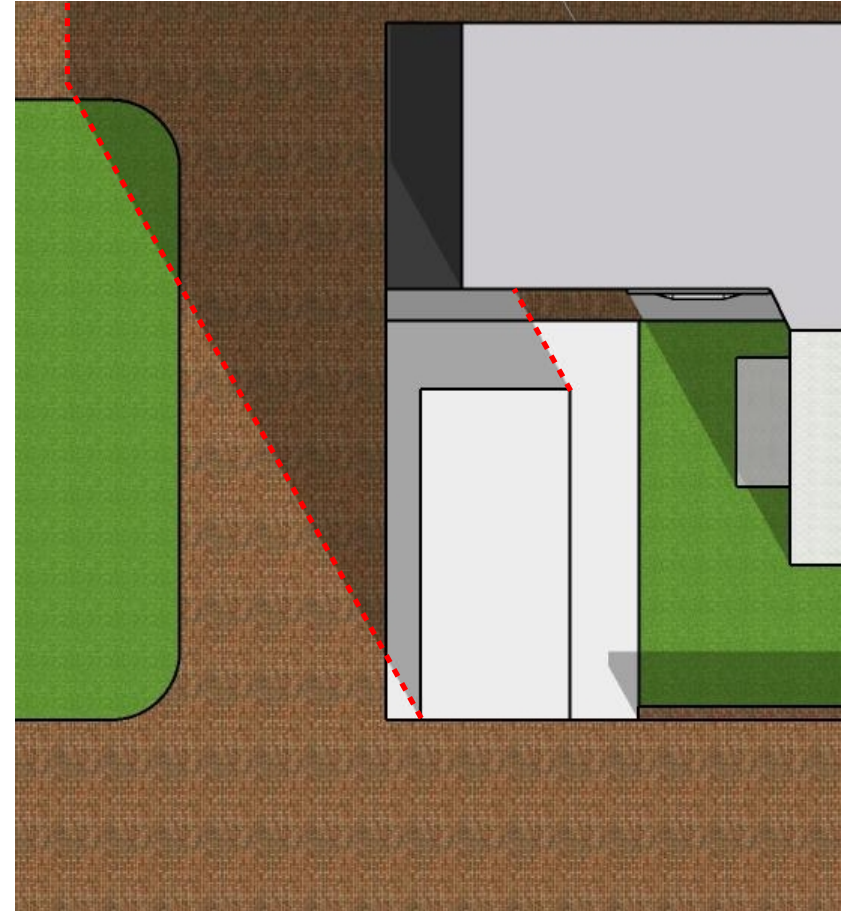

MATTER OF RIGHT



----- MATTER OF RIGHT

█ PROPOSED

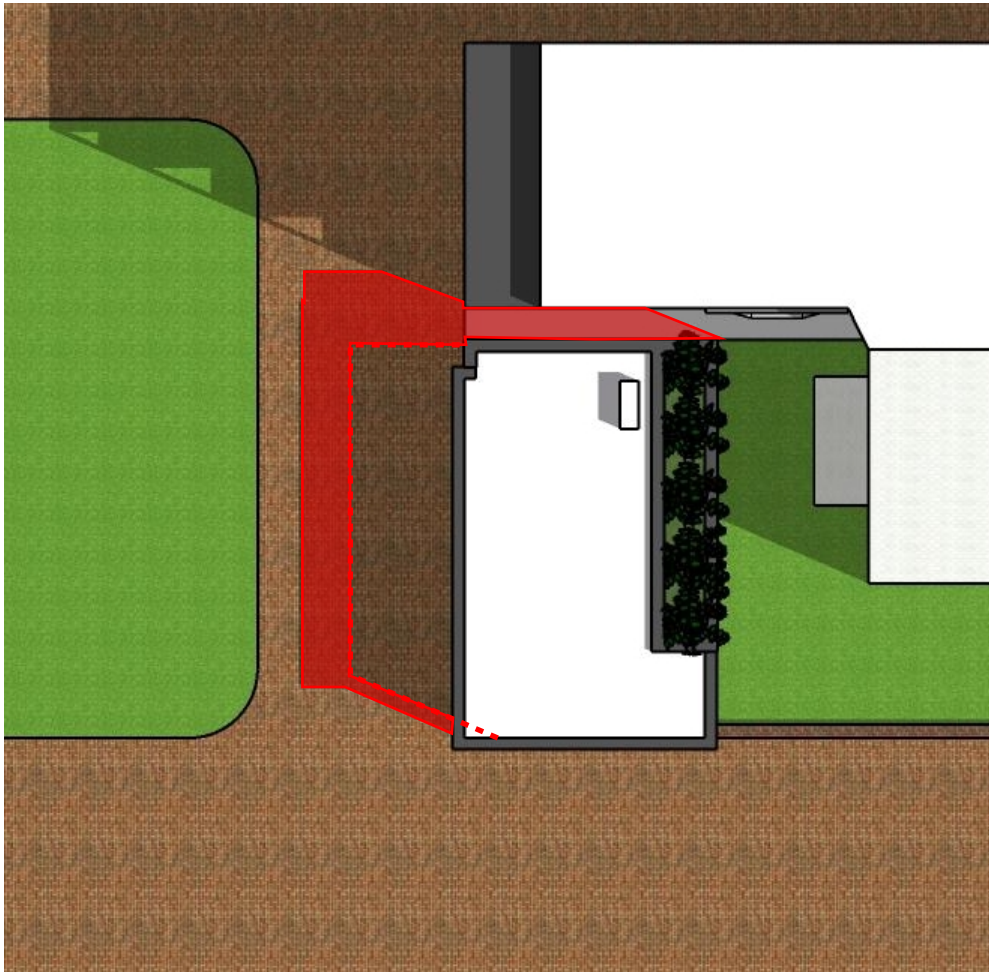

PROPOSED

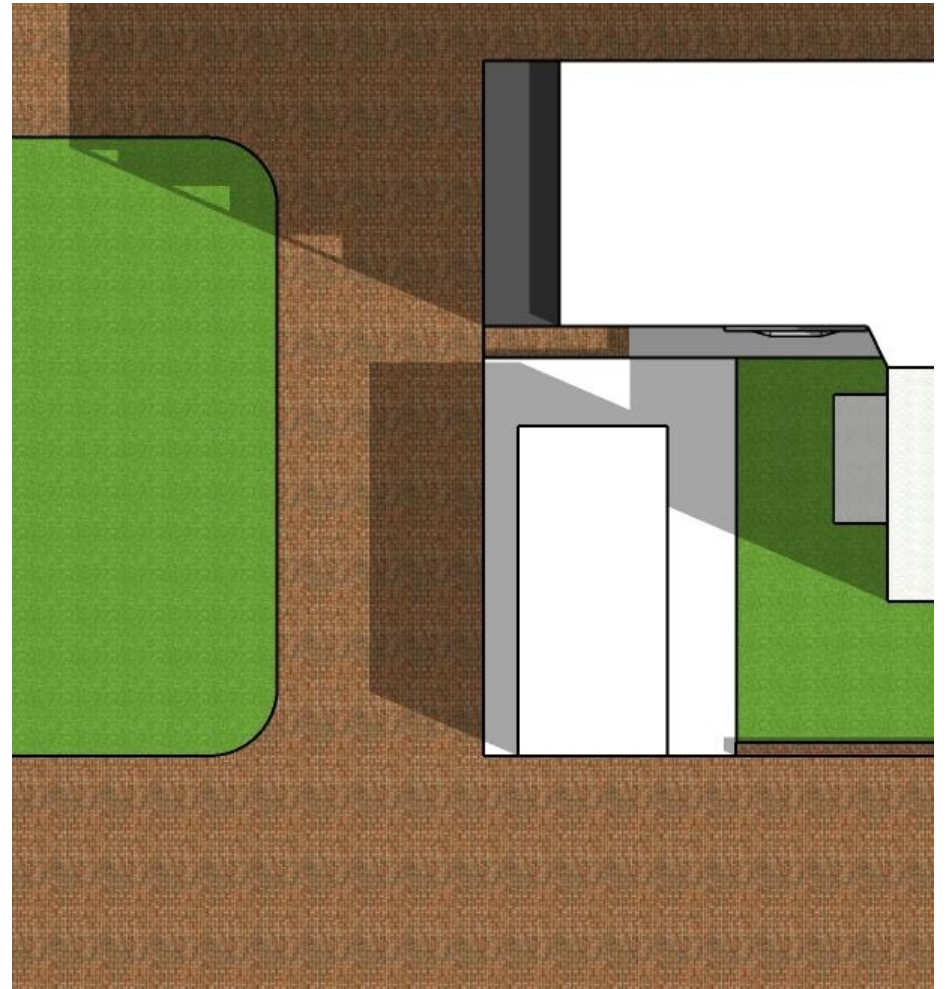

MATTER OF RIGHT



PAISNER RESIDENCE

SUMMER SOLSTICE 9:00 AM

General Requirements of X- 901.2

The granting of a special exception in this case “will be in harmony with the general purpose and intent of the Zoning Regulations and Zoning Maps” and “will not tend to affect adversely, the use of neighboring property in accordance with the Zoning Regulations and Zoning Maps ...” (11 DCMR Subtitle X § 901.2).

- Single family dwelling on an alley lot is a matter of right use
- Based on agency findings (including ANC, DDOT, DPW) the granting of the special exception will not tend to affect adversely the use of neighboring property.

Specific Requirements of C-306.4

In order to convert the alley tax lot to an alley record lot via special exception, the Applicant must meet the requirements of C § 306.4, and the lot must have been created prior to September 6, 2016. According to a deed, included with this Application, the tax lot has existed since at least 1959. The proposal in this Application satisfies the requirements of 11 DCMR Subtitle C § 306.4(a) and (b) as follows:

Section 306.4(a): The Alley Tax Lot connects to an improved public street through an improved alley or system of alleys that provides adequate public safety, and infrastructure availability; and;

- The adjacent alley to the south is 30 ft. wide and the adjacent alley to the west is effectively 15 ft. wide.
- DPW has no objection and stated “Based on DPW’s inspection, we have determined that the proposed construction at the subject property should have no impact on DPW’s collection operations.” (Exhibit 28)
- DDOT has no objection and stated “DDOT has no objection to the approval of this application, including relief from the alley centerline setback requirement of 7.5 feet (5 feet provided). It is common in the District for buildings, garages, and fences to be constructed up to the property line along 10 foot alleys.” (Exhibit 27)

Section 306.4 (b): The Office of Zoning shall refer the application to the following agencies for their review and recommendation, if filed to the case record within the forty (40) day period established by Subtitle A § 211: (1) Department of Transportation (DDOT); (2) Department of Public Works (DPW); (3) Metropolitan Police Department (MPD); (4) Fire and Emergency Medical Services Department (FEMS); (5) DC Water (WASA); and (6) If a historic district or historic landmark is involved, the Historic Preservation Office (HPO).

Specific Requirements of E-5201

In order to obtain relief from the rear yard setback, side yard setback, and the alley centerline setback, the Application must meet the criteria for relief under E § 5201.4-7:

E § 5201.4: An application for special exception relief under this section shall demonstrate that the proposed addition, new building, or accessory structure shall not have a substantially adverse effect on the use or enjoyment of any abutting or adjacent dwelling or property, specifically:

(a) The light and air available to neighboring properties shall not be unduly affected;

- The Subject Property is a small, 532 square-foot lot that abuts a large apartment building to the east and north. The Applicant is requesting relief to build a single-family dwelling that extends lot line to lot line, rather than be set back five feet (5 ft.) from the northern lot line and two and half feet (2.5 ft.) from the alley. The proposed Building will comply with the height, stories, and lot occupancy requirements for alley lots in the RF-1 Zone.
- The Applicant has provided a shadow study showing that any impacts are limited and do not rise to the level of undue.

(b) The privacy of use and enjoyment of neighboring properties shall not be unduly compromised

- There are no windows proposed on the north or east side of the Building. The proposed west-facing windows will face Sladen's Park across the alley, which has multiple trees.
- The proposed window on the south-side of the Building is facing the thirty-foot (30 ft.) wide alley and has been designed to let light in without compromising privacy.

Specific Requirements of E-5201

(c) The addition or accessory structure, together with the original building, as viewed from the street, alley, and other public way, shall not substantially visually intrude upon the character, scale, and pattern of houses along the subject street frontage; and

- The design of the proposed Building is subject to review and approval by HPRB. Regardless, the Building shall not substantially visually intrude upon the character, scale, and pattern of houses along the alley. The proposed renovation should improve the view of the alley.
- The Applicant worked closely with neighbors and the ANC in redesigning the originally proposed structure.

5201.7 Where an application requests relief from the alley centerline setback requirements under this section, the Office of Zoning shall refer the application to the following agencies for their review and recommendations, to be filed in the case record within the forty- (40) day period established by Subtitle A § 211: (a) District Department of Transportation (DDOT); (a) Department of Public Works (DPW); (b) Metropolitan Police Department (MPD); (c) Fire and Emergency Medical Services Department (FEMS); (d) DC Water (WASA); and (e) If a historic district or historic landmark is involved, the Historic Preservation Office (HPO).

Questions?