

PAISNER RESIDENCE

117 12TH ST SE, LOT 807, WASHINGTON, D.C. 20003

PROJECT DATA

OWNER:	PAISNER, ERIC J. AND PAISNER, ELIZABETH P.
EXISTING	RESIDENTIAL-GARAGE
PROPOSED	RESIDENTIAL-SINGLE-FAMILY-DETACHED
PROJECT DESCRIPTION	CONSTRUCTION OF A NEW, SINGLE FAMILY, TWO STORY DETACHED RESIDENCE

ZONING DATA

SQUARE / LOT	0989 / 0807	
ZONE	RF-1	
USE GROUP	R-3	
CONSTRUCTION TYPE	VB	
STORIES	EXISTING	PROPOSED
LOT SIZE	1	2
LOT OCCUPANCY	532 SF	NO CHANGE
	135 SF / 25.4%	532 / 100%

VICINITY MAP

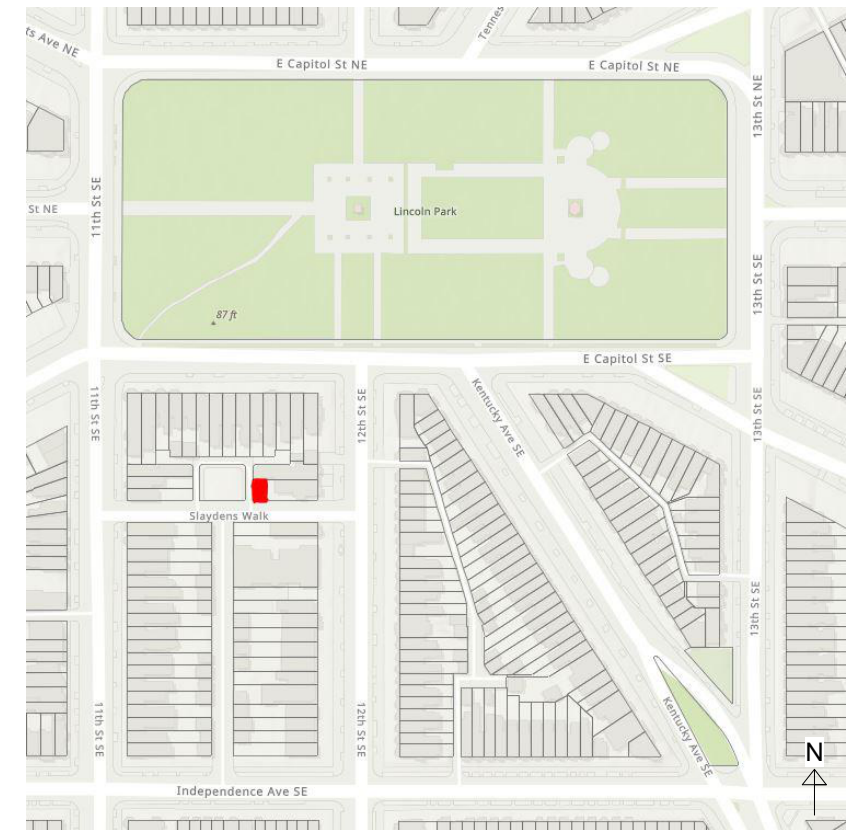

PROJECT TEAM

ARCHITECT
EUSTILUS LLC
ERIC TERAN
2800 N. ROSSER ST
ALEXANDRIA, VA 22311
202-569-9620
ETERAN@EUSTILUS.COM

SHEET INDEX

01	COVER
02	SITE PLAN
03	FLOOR PLANS
04	ELEVATIONS
05	SECTIONS
06	EXISTING & DEMO PLANS
07	PARKING DIAGRAM

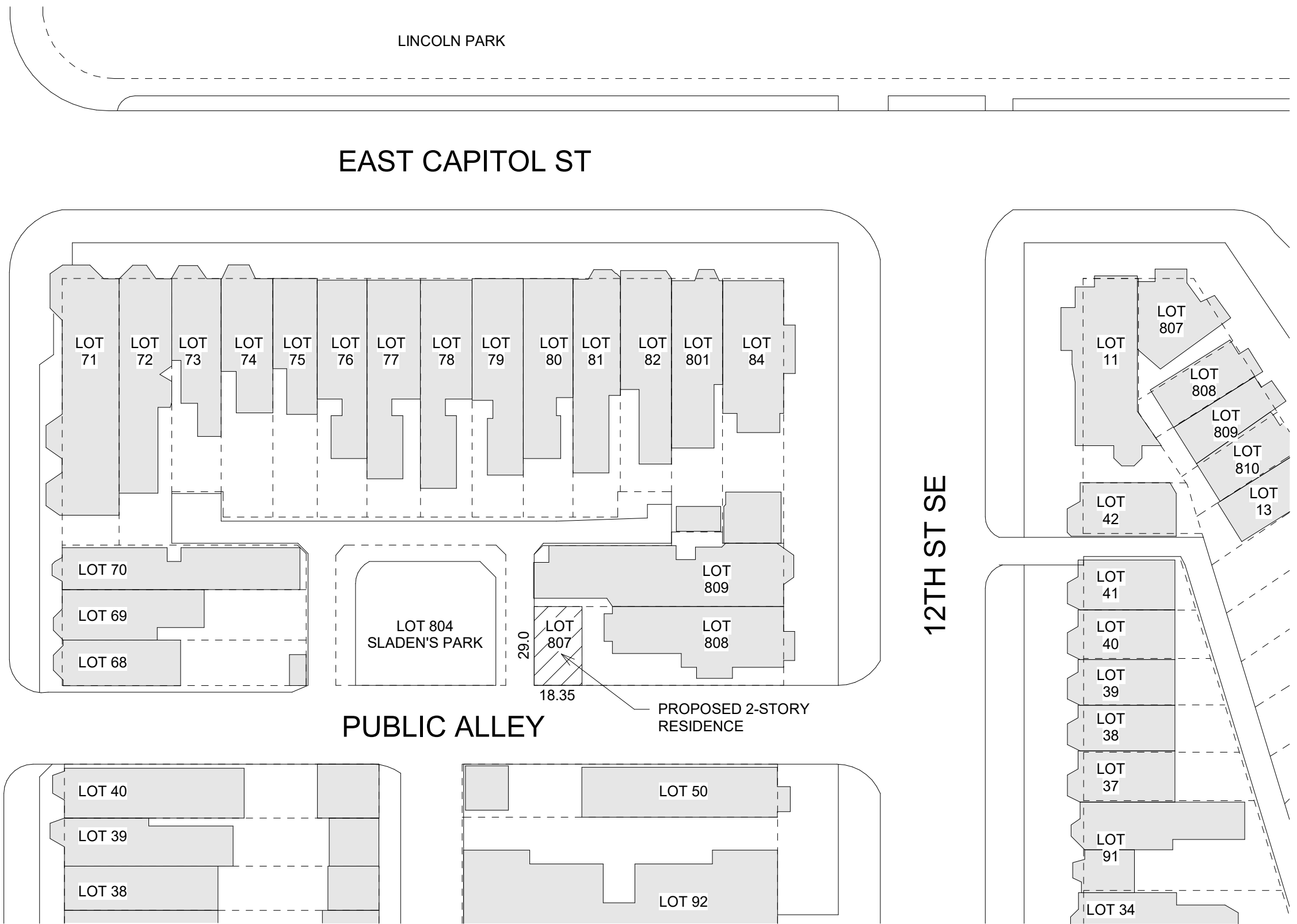
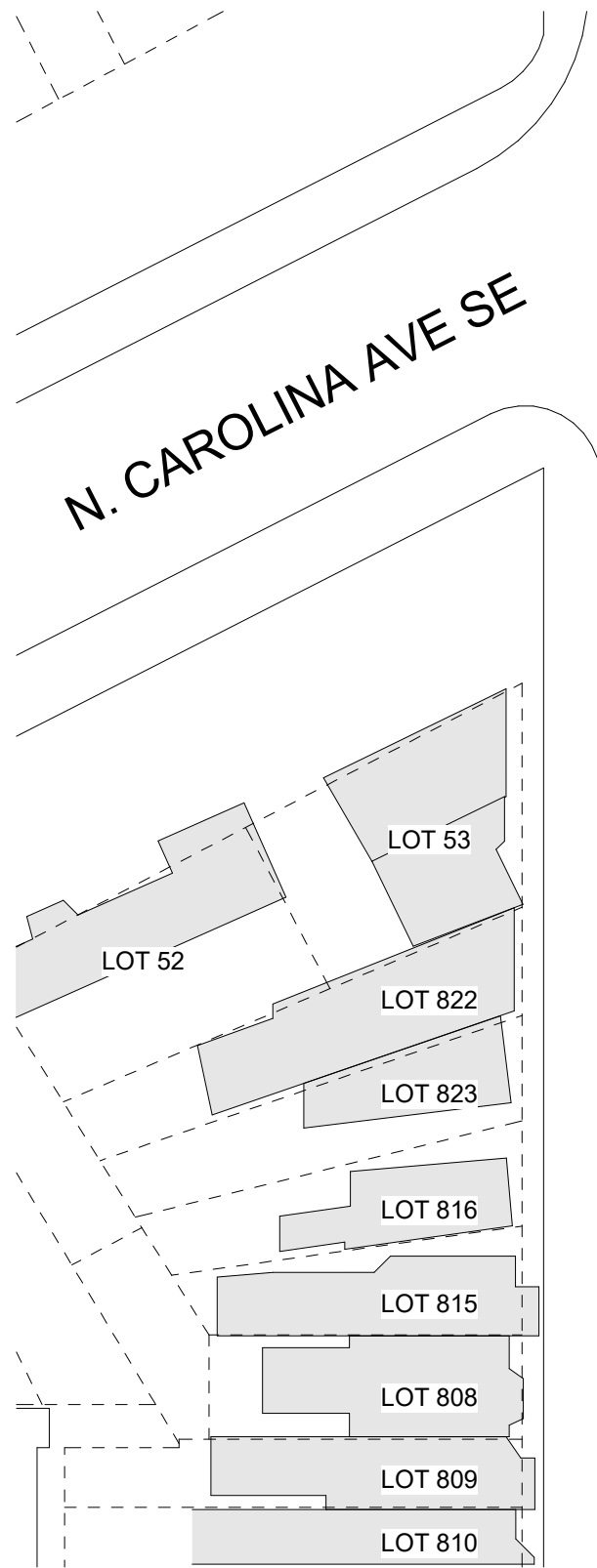

PAISNER RESIDENCE

SITE PLAN



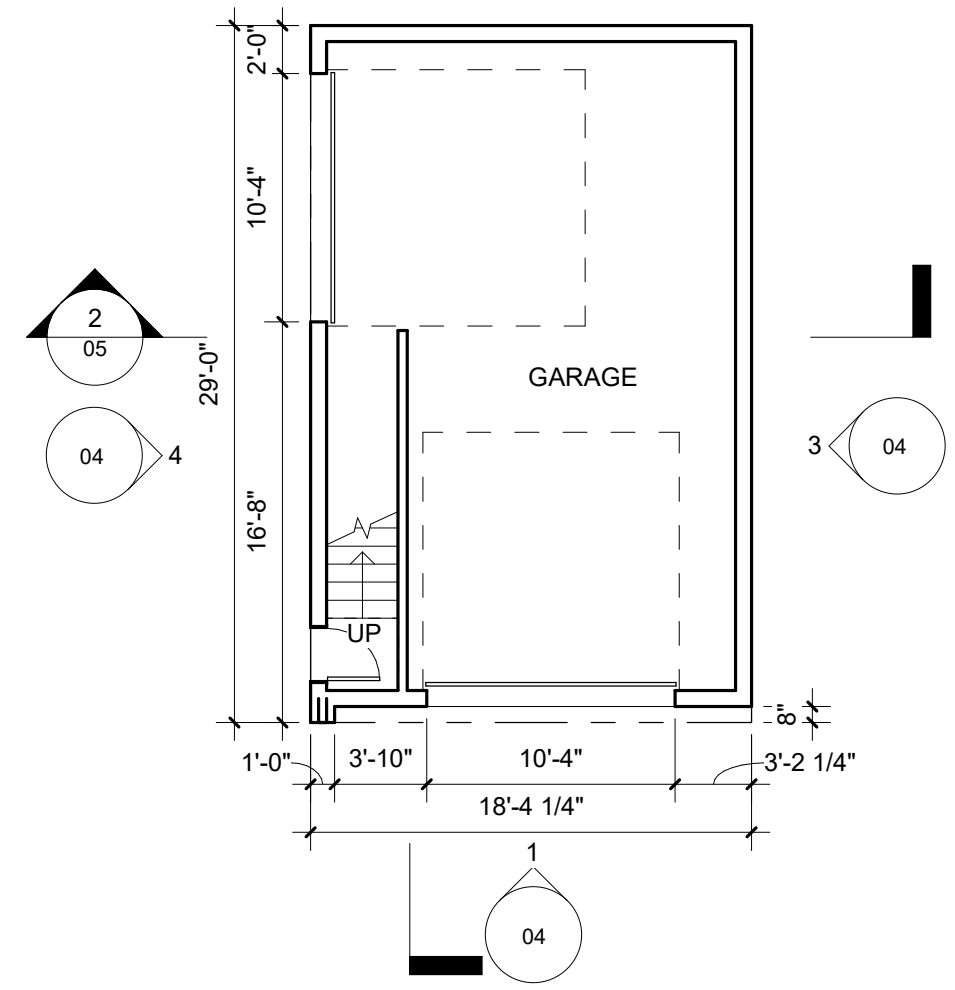
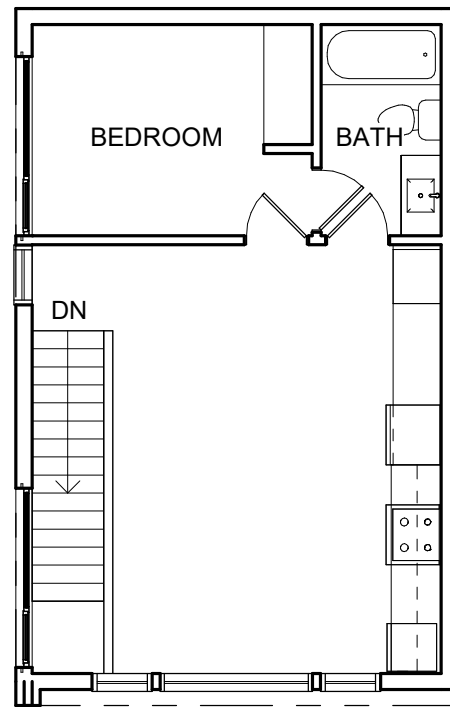
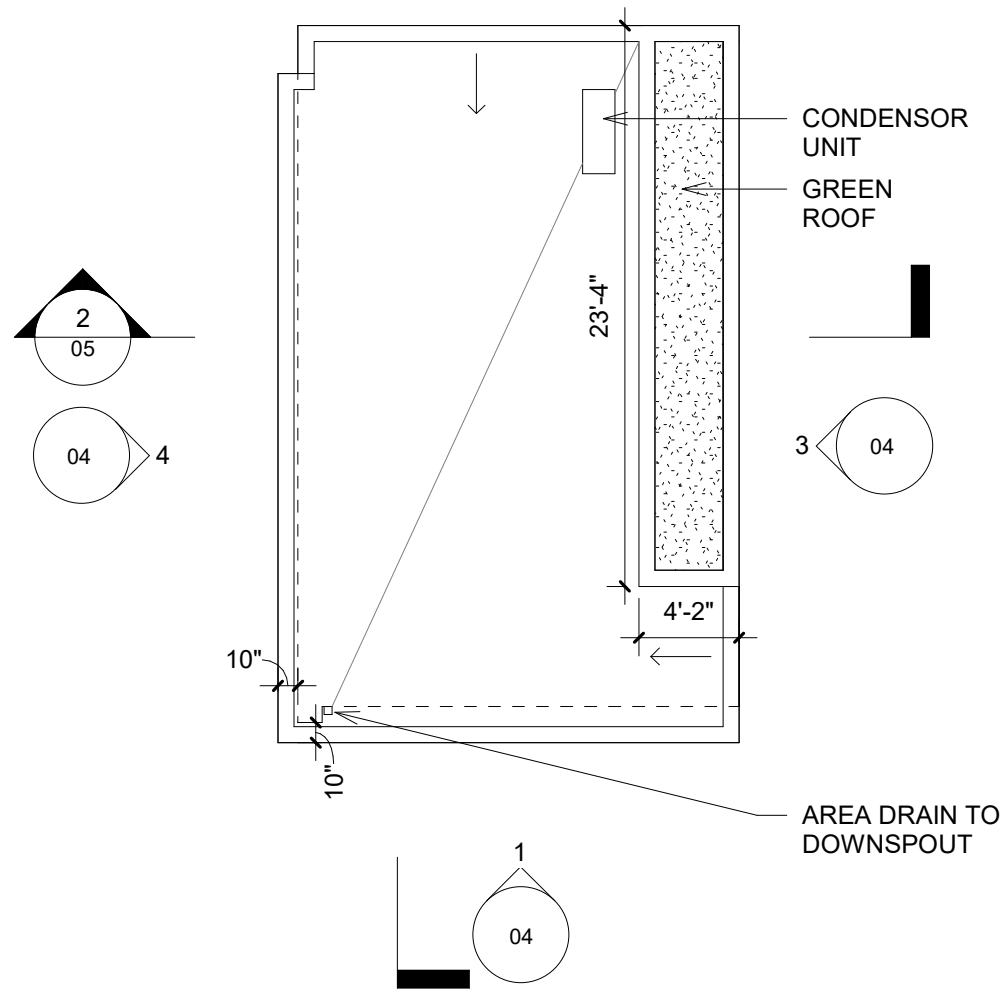
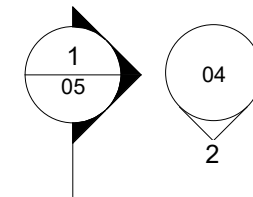
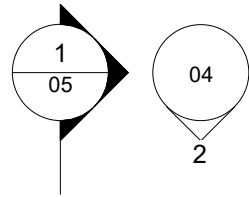
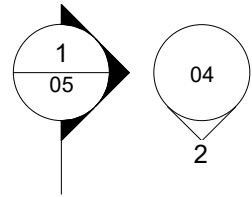

3 ROOF
1/8" = 1'-0"



2 LEVEL 02
1/8" = 1'-0"

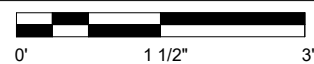

1 LEVEL 01
1/8" = 1'-0"



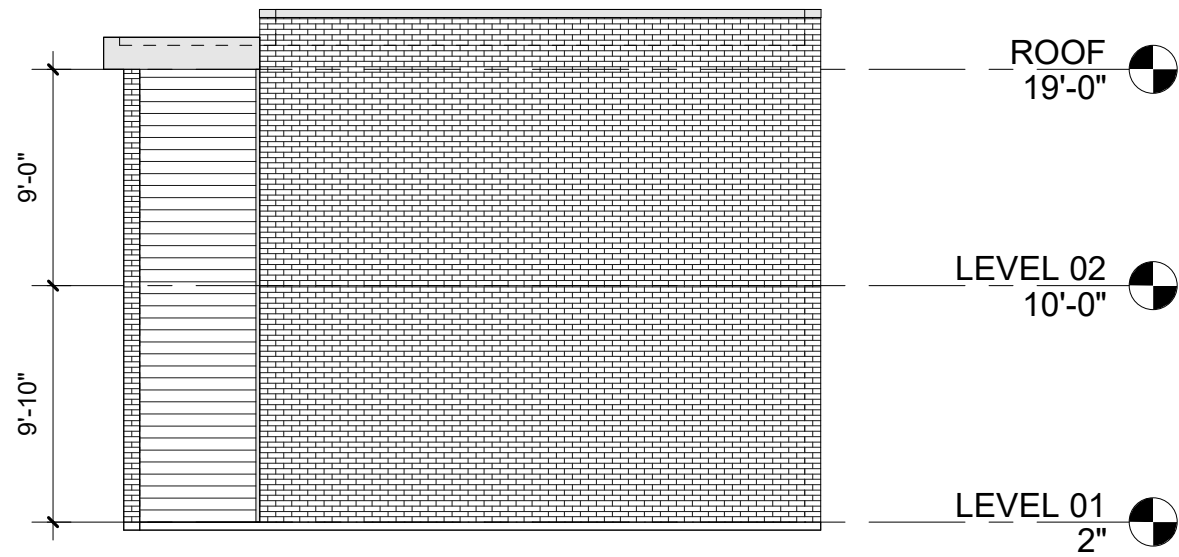

3 EAST ELEVATION

1/8" = 1'-0"

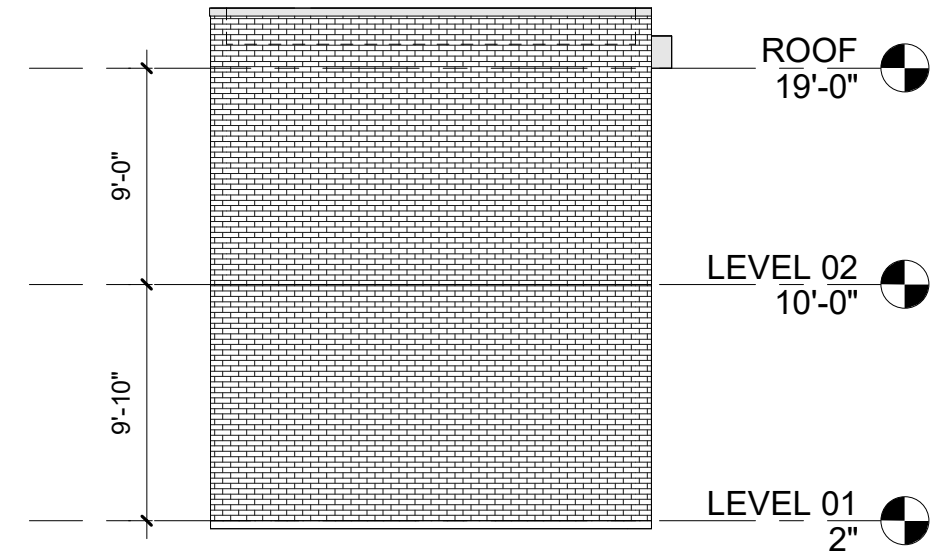
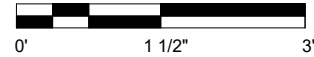

2 NORTH ELEVATION

1/8" = 1'-0"

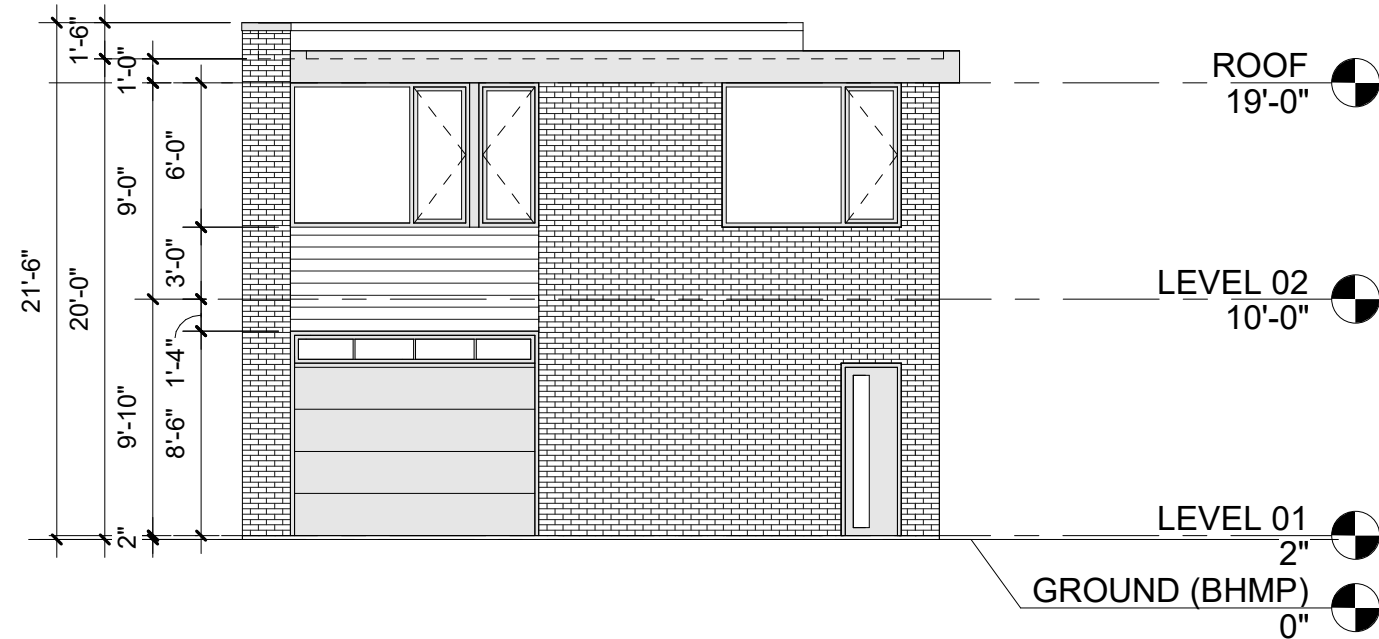
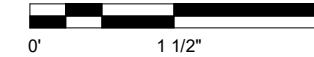

4 WEST ELEVATION

1/8" = 1'-0"

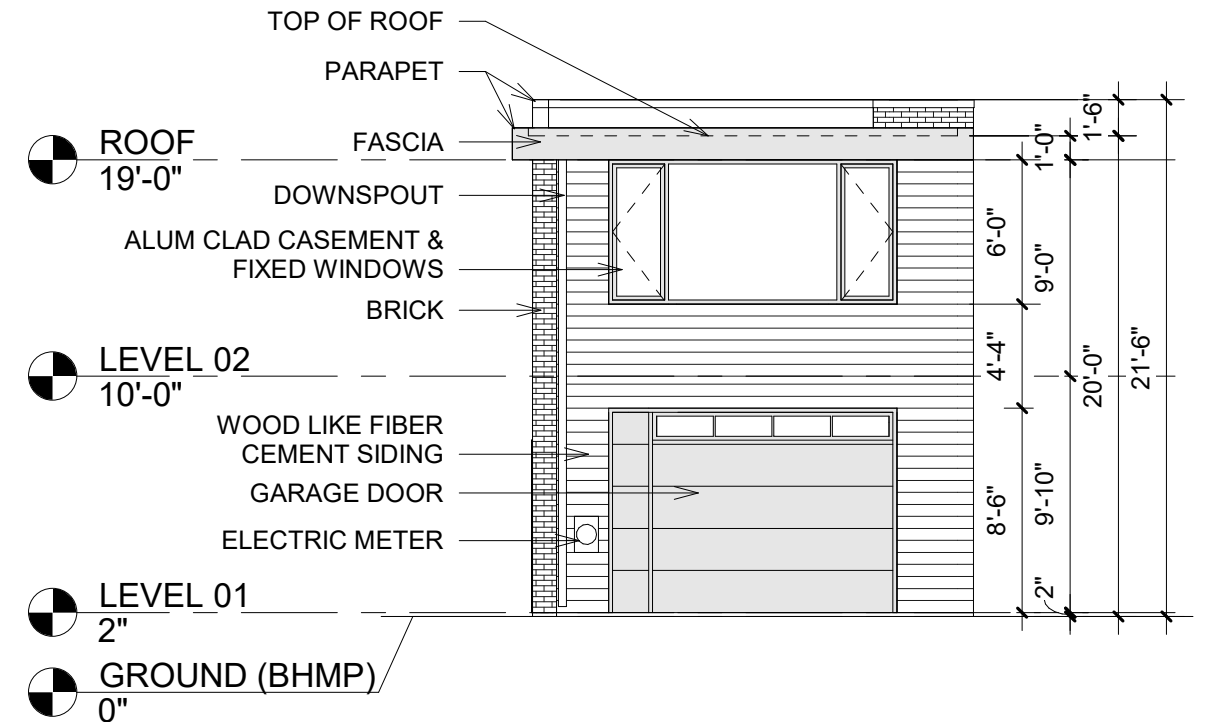
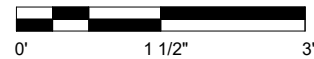

1 SOUTH ELEVATION

1/8" = 1'-0"

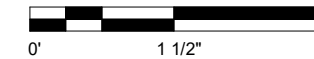

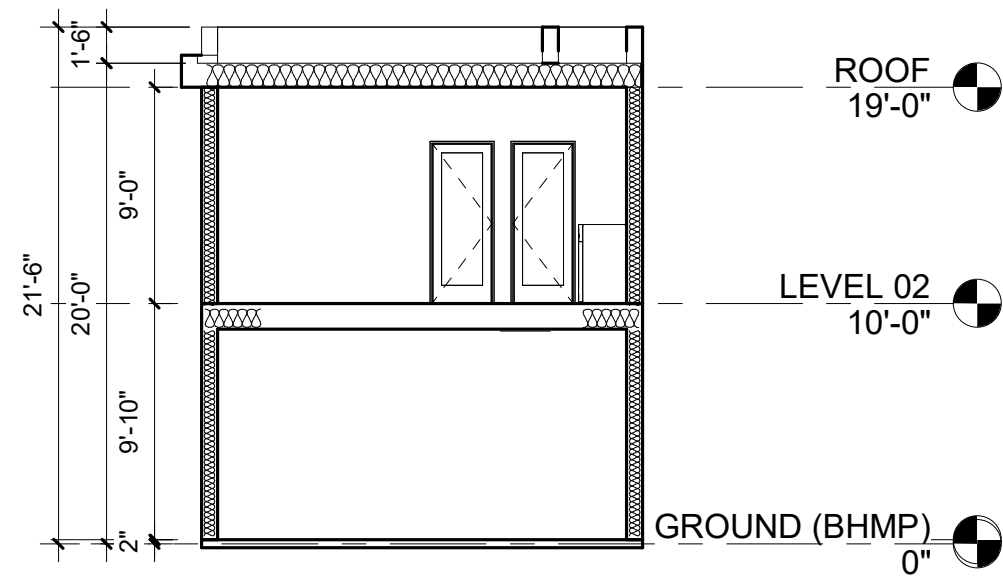

2 WEST-EAST SECTION
 1/8" = 1'-0"
 0' 1 1/2" 3"

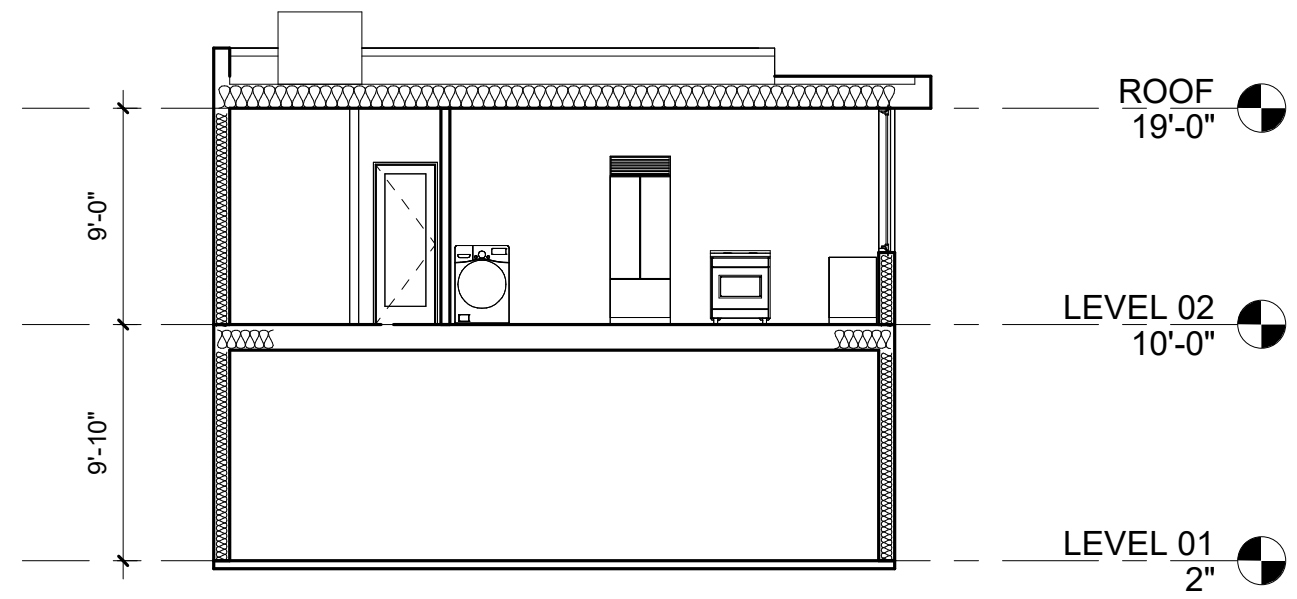

1 NORTH-SOUTH SECTION
 1/8" = 1'-0"
 0' 1 1/2" 3"

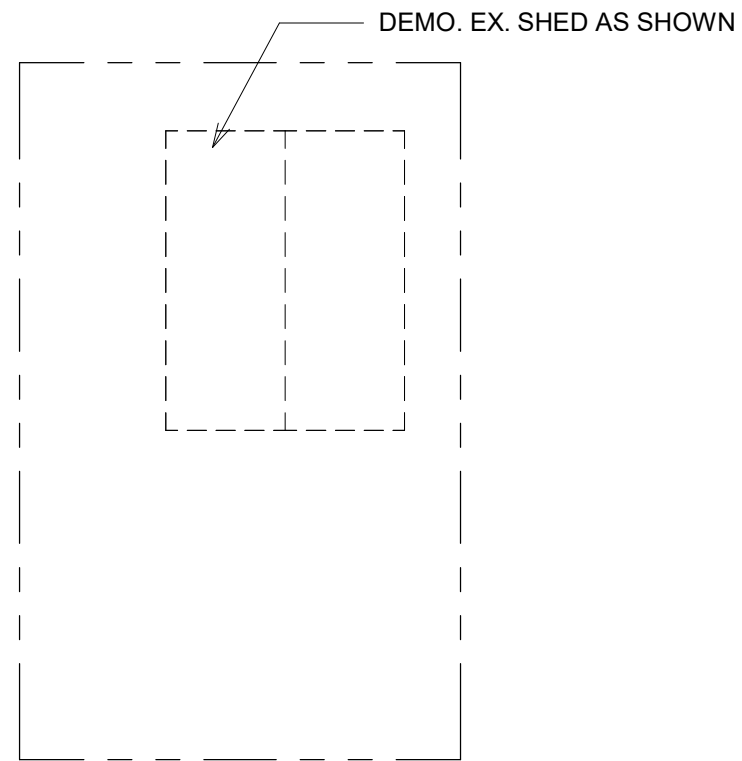

2 ROOF - DEMOLITION
 1/8" = 1'-0"
 0' 1 1/2" 3"
 N

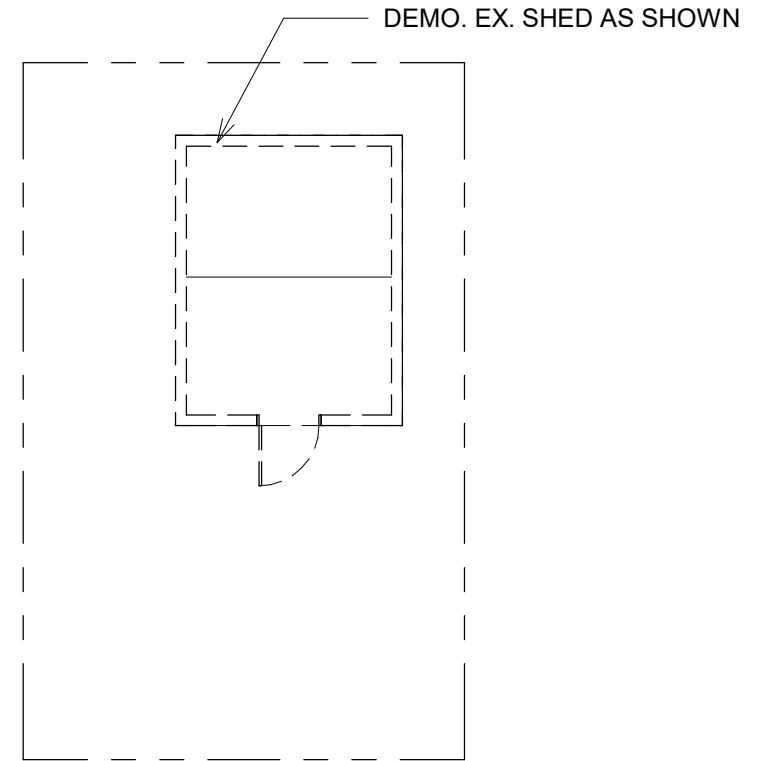

1 LEVEL 01 - DEMOLITION
 1/8" = 1'-0"
 0' 1 1/2" 3"
 N

