

PASSENGER CAR SPACE 1 - ENTER

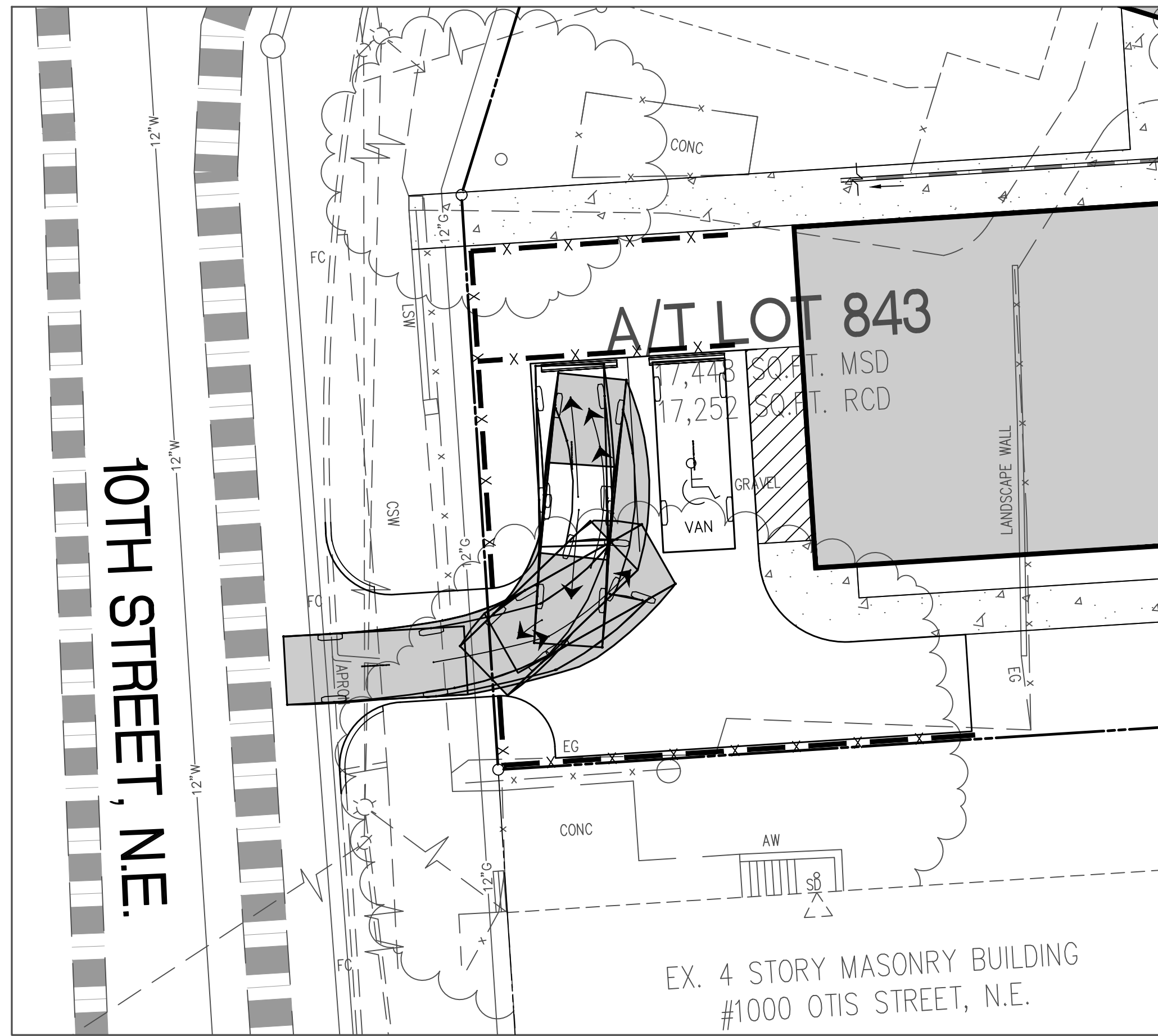

WHEELCHAIR VAN SPACE 2 - ENTER

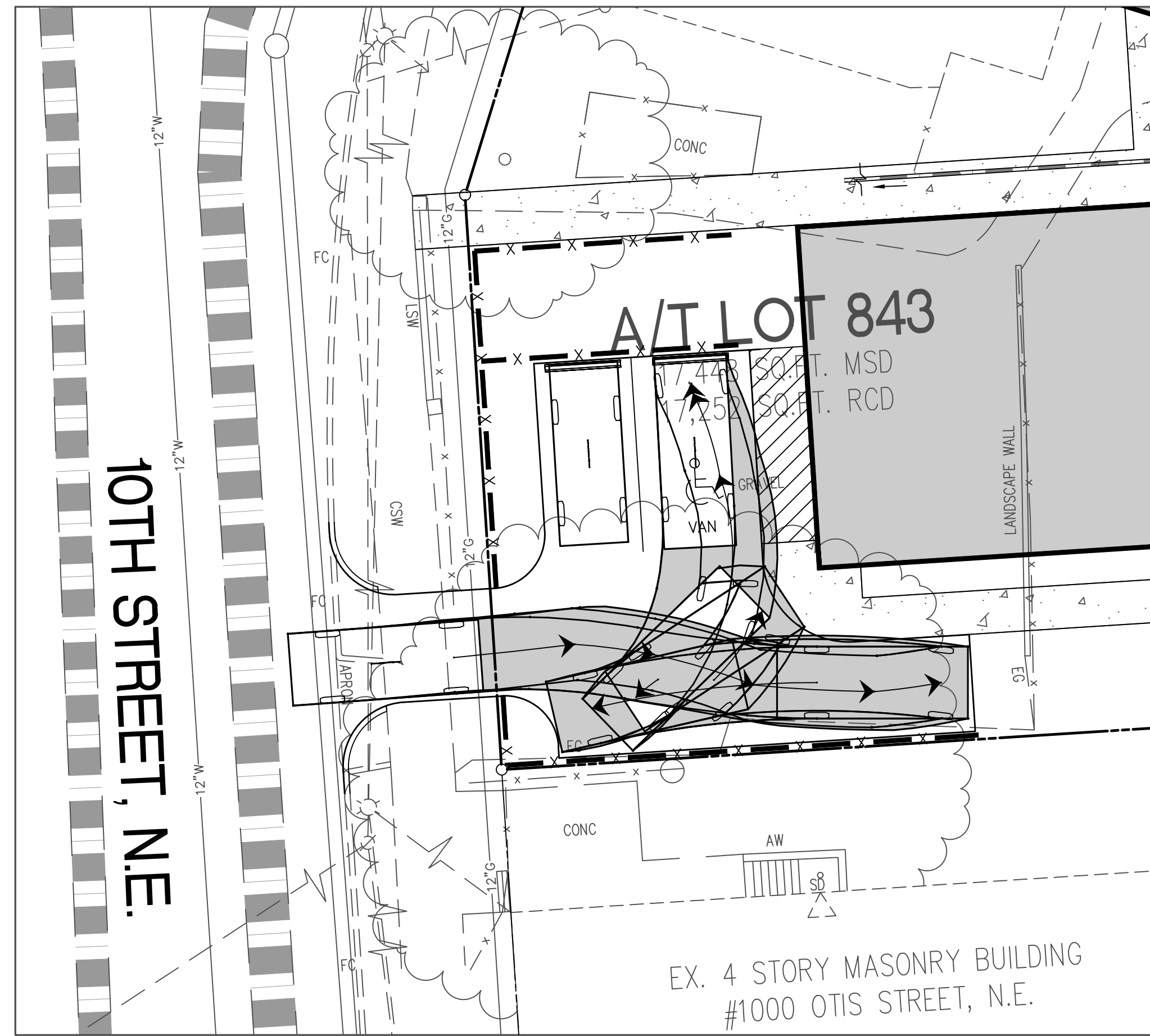

PASSENGER CAR SPACE 1 - EXIT

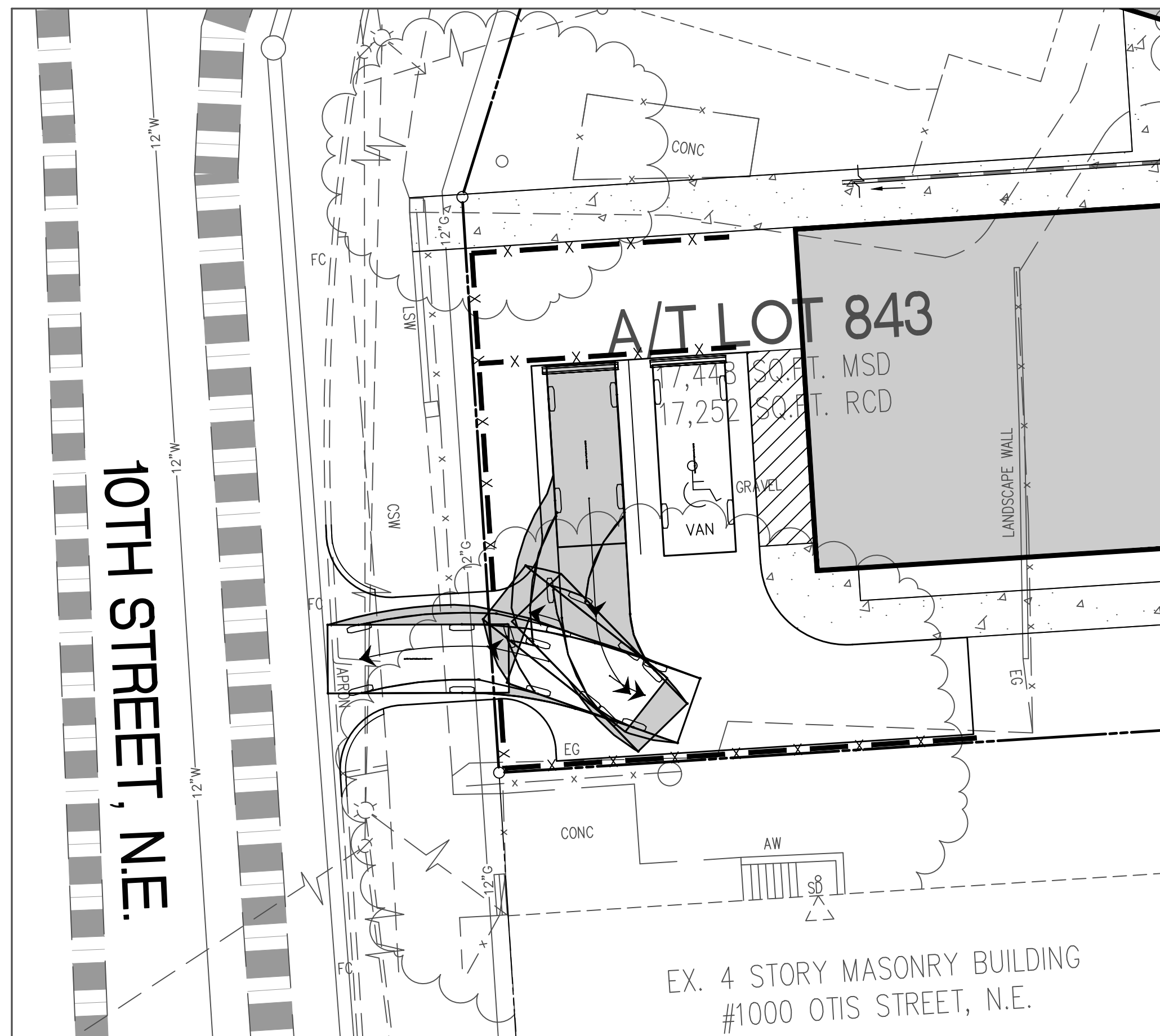

WHEELCHAIR VAN SPACE 2 - EXIT

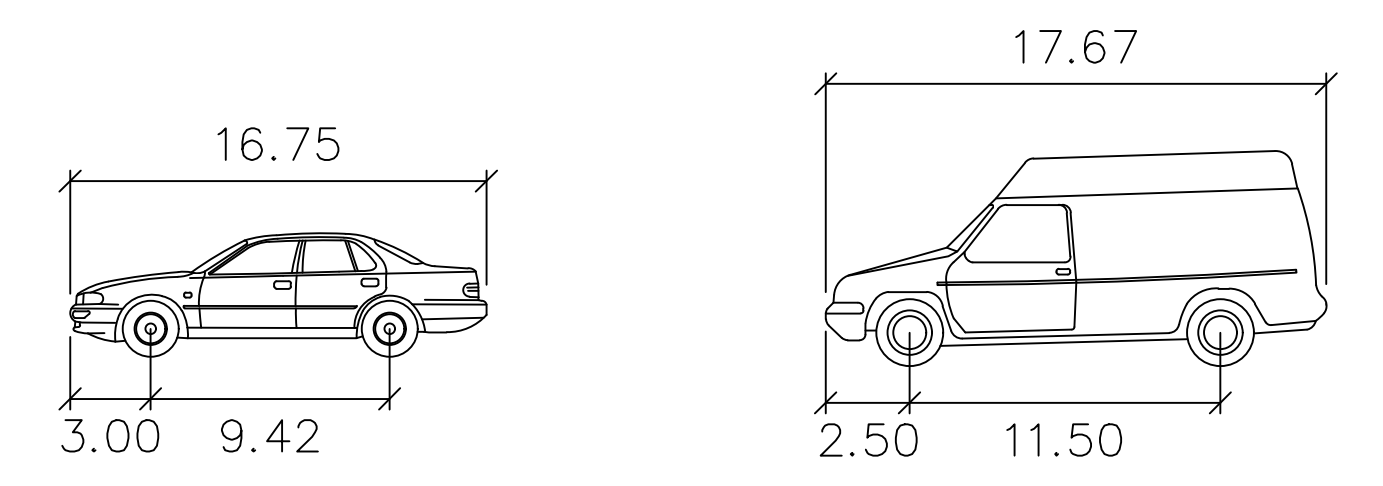
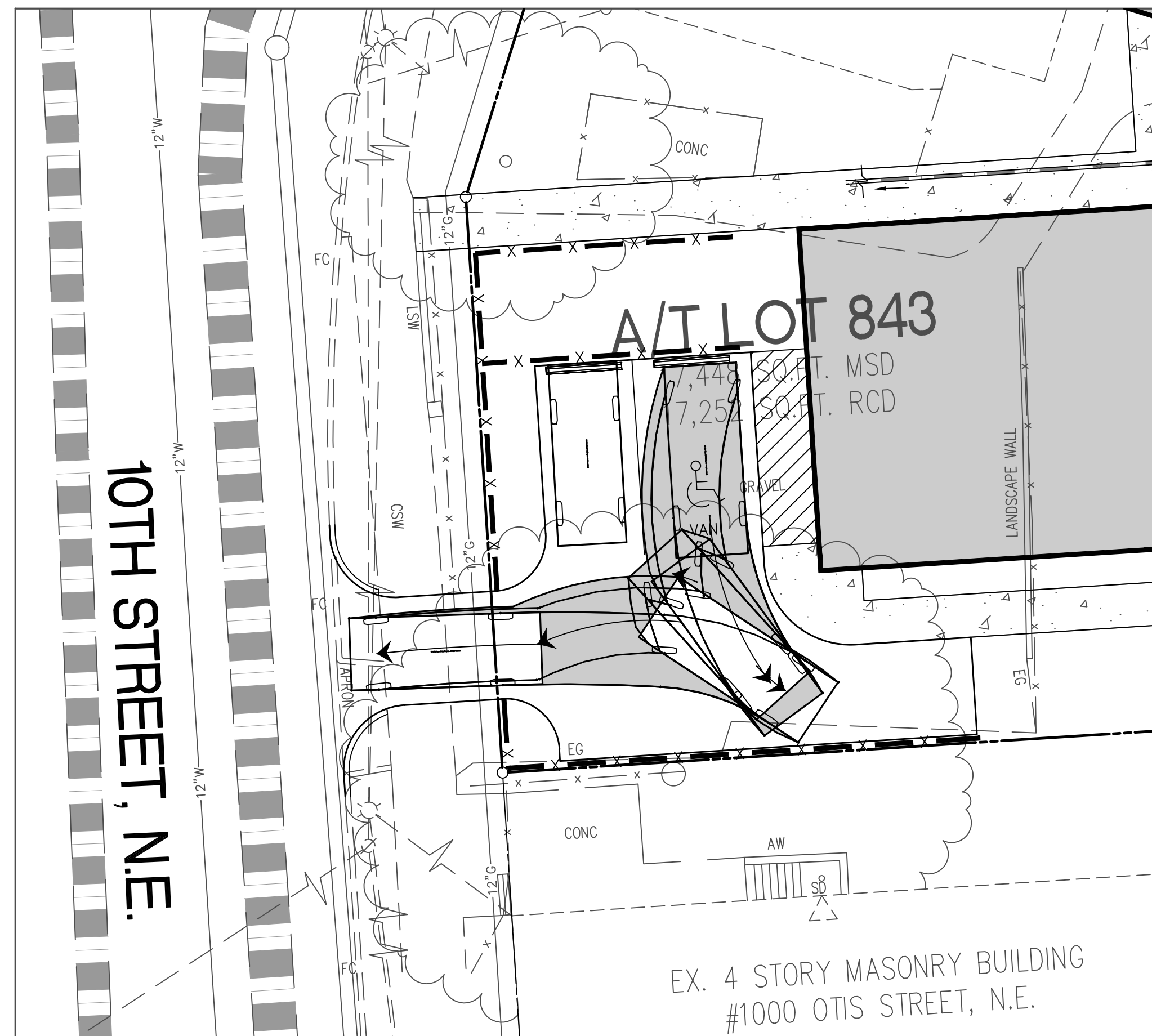

	feet		feet
Width	: 6.33	Width	: 6.67
Track	: 6.33	Track	: 6.67
Lock to Lock Time	: 6.0	Lock to Lock Time	: 6.0
Steering Angle	: 26.4	Steering Angle	: 31.7

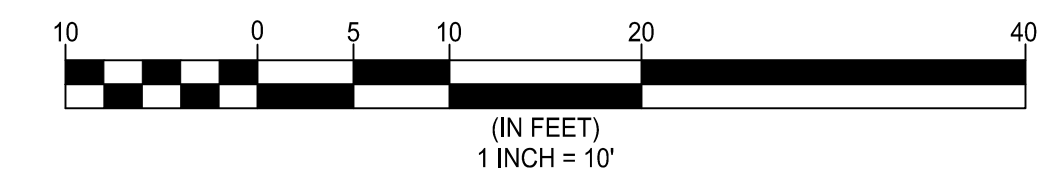

NOTES

1. VEHICLE MOVEMENTS SHOWN ON THIS SHEET PERFORMED USING AUTOTURN MODELING SOFTWARE.
2. EXACT VEHICLE MODEL AND MAKEUP MAY VARY.
3. THIS EXHIBIT WAS PREPARED FOR INFORMATIONAL PURPOSES ONLY.

1005 BUNKER HILL ROAD
 PREPARED BY
WALTER L. PHILLIPS INCORPORATED
 Engineers • Surveyors • Planners
 Landscape Architects • Arborists
 207 PARK AVENUE
 FALLS CHURCH, VIRGINIA 22046
 (703) 532-6163 Fax (703) 533-1301
 WLPINC.COM

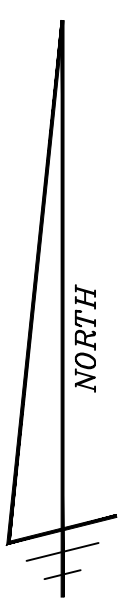

**CONCEPTUAL VEHICLE MOVEMENTS
 1005 BUNKER HILL ROAD**